



深圳市弗瑞鑫电子有限公司

规格承认书

—
————
————

prepare	
check	
approve	



TRX电容一级代理商

深圳市弗瑞鑫电子有限公司

Add:深圳市宝安区西乡大道302号金源商务大厦B座3楼

Tel:0755-29563634

Fax:0755-27447020

- 2

2 . .

/

/

/

/



- 2 2 . .			
/		/	
/		/	

	- 2 2 . .		
	/		/
	/		/

1. /

$\overline{\text{①}}$ $\overline{\text{②}}$ $\overline{\text{③}}$ $\overline{\text{④}}$ $\overline{\text{⑤}}$ $\overline{\text{⑥}}$

①

	- 2 2 . .		
	/		/
	/		/

3. /



4. /

5. /

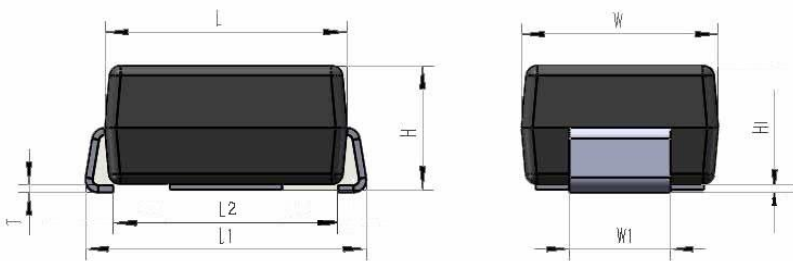



①		
②		
③		
④		
⑤		

- 2
2 ..

/

/

/

	- 2 2 . .		
	/		/
	/		/

/

°
°C

°

°

°

/

7. /



- 2 2 . .			
/		/	
/		/	

				<table border="1" style="width: 100%; height: 20px;"> <tr> <td></td><td></td><td></td><td></td><td></td><td></td> </tr> <tr> <td></td><td></td><td></td><td></td><td></td><td></td> </tr> </table> △												
				±												



- 2
2 ..

/

/

/

/

					±
		±			
		±			
		±			
		±			

/

/

/

/

			\pm \pm \pm \pm \pm
			\pm \pm \pm \pm \pm

8. /

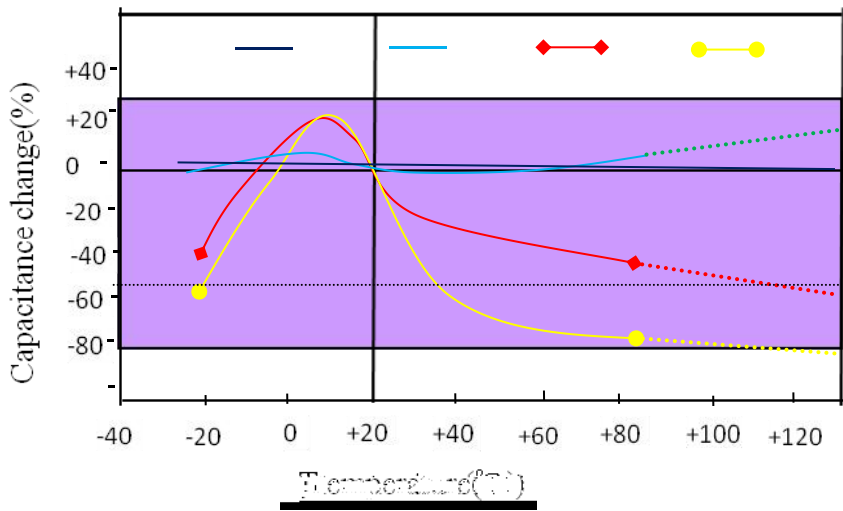

 TRX 专注电容器廿年	- 2 2 . .		
	/		/
	/		/

9. /



10. /
(1)

(2)

/
/

(3)

(4)

×

11. /
/

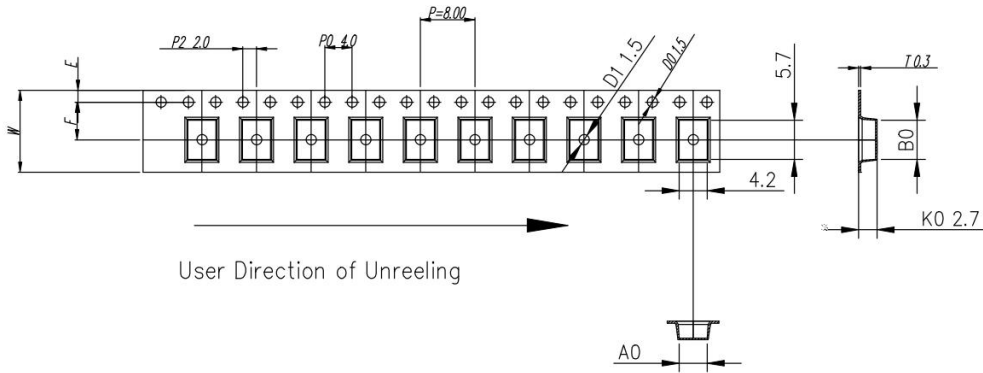

ITEM	W	A0	B0	K1	K0	P	F	E	D0	D1	P0	P2	T
DIM	12.0	$4.0^{+0.30/-0.30}$	$5.70^{+0.10/-0.10}$	--	$2.70^{+0.10/-0.10}$	8.00	$5.50^{+0.10/-0.10}$	1.75	$\phi 1.5^{+0.10/-0.10}$	$\phi 1.5^{+0.10/-0.10}$	4.0	2.0	0.30
ALTERNATE													

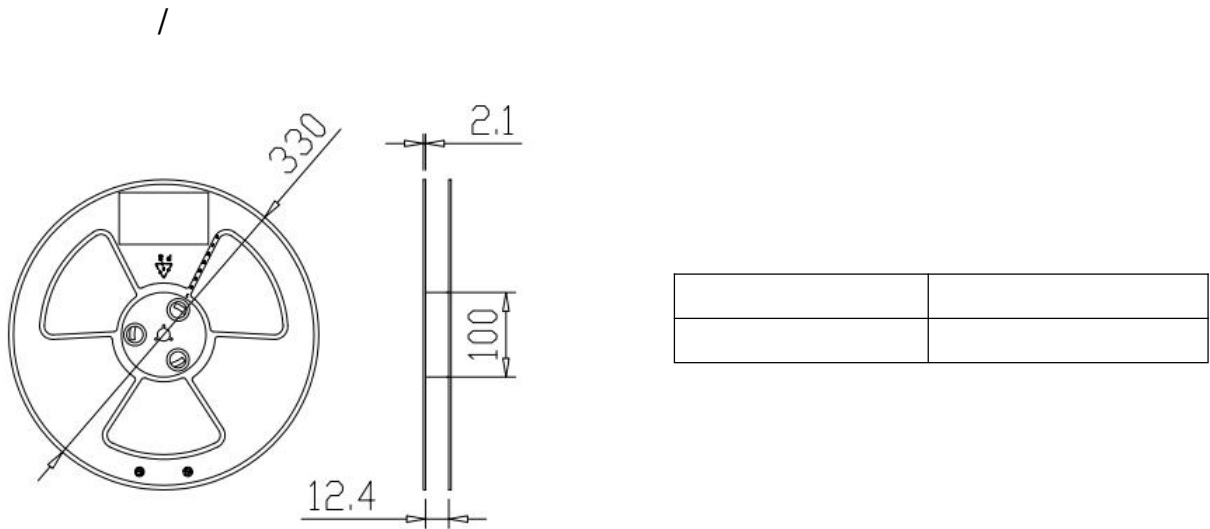

/

Item	Data	Remark
Cover tape adhesion	10 ~ 100g	Carrier tape and cover tape open angle 165 ~ 180° F=300±5mm/minute

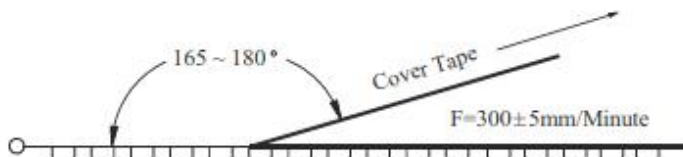



- 2
2 . .

/		/	
/		/	

/ -

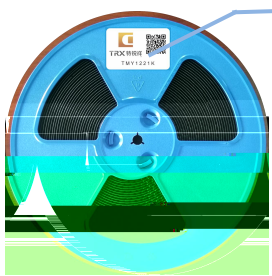

标签



料号

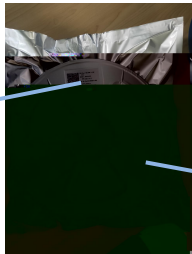

/ -

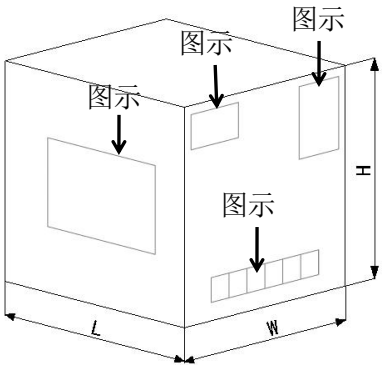

图示 /

图示 /

图示 /

/ :



/



/

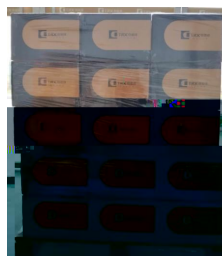

" "

	- 2 2 . .		
	/		/
	/		/

12. / 

①

②