

深圳市弗瑞鑫电子有限公司

规格承认书

—

prepare	
check	
approve	



TRX电容一级代理商

深圳市弗瑞鑫电子有限公司

深圳市宝安区西乡大道302号金源商务大厦B座301

0755-29563634

0755-27447020



	/ ..			



1 4.1

2 4.1

3 4.1

B - : 4000 AC
 : 50/60
 : 60

4 4.2.1

B - : 4000 AC
 :

8	4.2.5	B	6000	100	C : 50/60 60 5 A
		B	6000		
9	4.3		>10		
10	4.4				260 5 : 10 1 :
			4.2.1	2 ⁺⁰ -0.5	
		C	4.2.1 : 5% 5 : 10% 5 : 20% 5 : 20%	2 ⁺⁰ -0.5 1.5 0.5 1.5 0.5 C 25 3	
			5 1.0% 5 :5 2.5% 5 5 2.5% 5 :5 2.5%	24 2 25 3 24 2	
			4.2.5 4.2.5		
11	4.5		3 .		235 5 : 0.5 (): C 2 ⁰ -0.5 , 1.5 0.5 20-0.5 1.5 0.5

12	4.6			+125 3	
				-25 3	
			4.2.1	:5	
		C	4.2.1 : 5% 5 : 10% 5 : 20% 5 : 20%	30 30	C
			5 1.0% 5 :5 2.5% 5 5 2.5% 5 :5 2.5%	25 3 24 2 25 3 24 2	
			4.2.5		
13	4.7	C		10 55 10 : 0.75 , 6 6 2 2	6 2
14	()			40 2	
		C	$= (C - C_0) / C_0$: 15%	: 95 3%	
			4.2.1	: 500+24/-0 : 500 AC 400	
			3000 $= (- 0) / 0$ >50%	25 3 24 2 25 3	24 2





19 4.19
C

4.2.1 4.2.5

4.2.1 4.2.5

/		

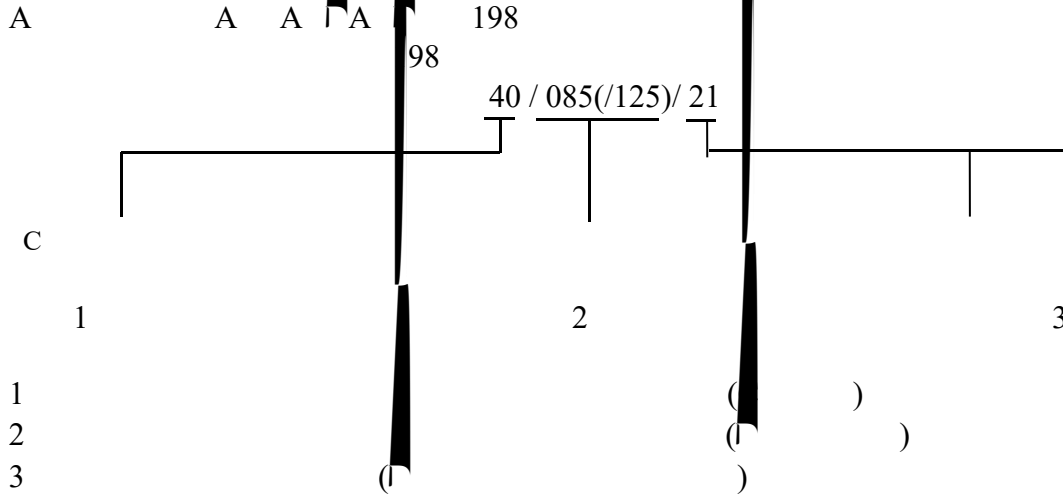

C	C 60068-1 C 60068-1
	25/085/04
	25/085/21
	40/085/21
	55/125/21
	55/125/56

(C)	
65	-65
55	-55
40	-40
25	-25
10	-10
00	0
05	+5

()	
155	+155
125	+125
110	+110
085	+85
080	+80
075	+75
070	+70

()	
56	56
21	21
10	10
04	4
00	

2.0 2011/65/

AC 190 7/2006



		(:)
C		<100
		<1000
		<1000
		<1000
	BB	<1000
	B	<1000
C + + + C +6() + + +		<100
C		<900
B		<900
C +B +		<1500
C (155) AC	174	<1000

	/ ..			



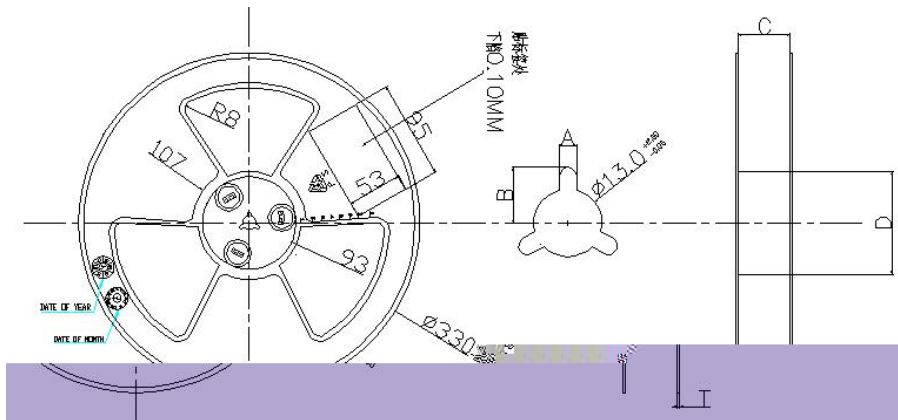
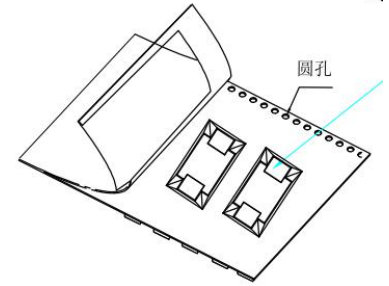
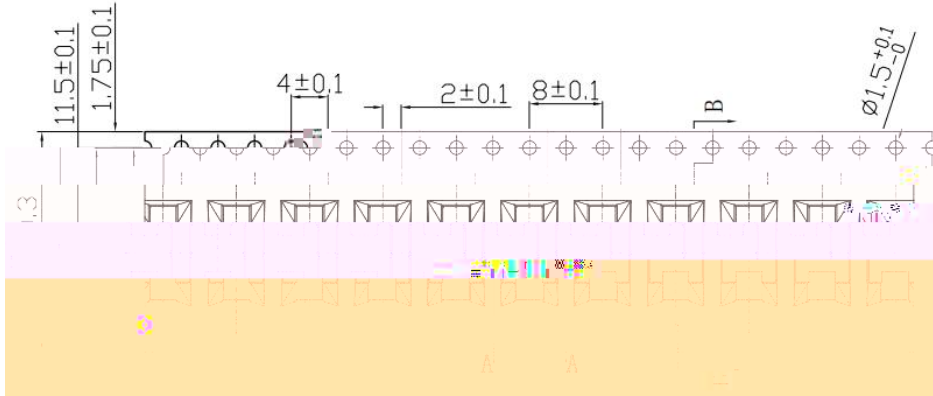





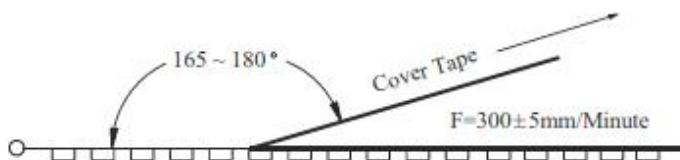

SPEC	A±0.3	B±0.5	C ^{+0.5} / _{-0.0}	D±0.5	T±0.2
24	2.3	10.75	24.4	Ø97	2.2

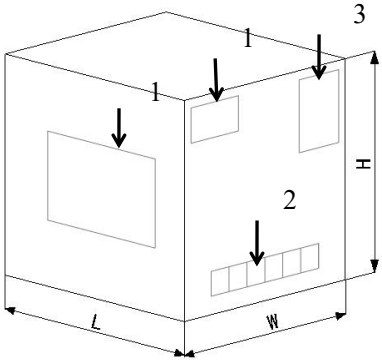
Item	Data	Remark
Cover tape adhesion	10~100g	Carrier tape and cover tape open angle 165~180° F=300±5mm/minute



 <p>13 3.0 C /</p>			
			C
			#

				
				B
			355	358

 <p>B</p>	 <p>10 /B</p>	 <p>(/ /) 1100*1100*90</p>	 <p>(/ /) 1100*1100*1600</p>
1. 5	5 ;2. A	&	A ;3.50
:1. 5	;4. /	' 5	;2. & -
/	;3.50		;4.

	/ ..			

..
C

..

C

.. .. ,

+k

ZHK 7 0 TD[(D)]TJ 93.594 0 TDD[(D)]TJ 93.594 0 0]TJ 93.5938 0 TD -TDD[(D)]TJ

	/ ..			

():

.C



TRX 特锐祥

专 注 电 容 器 11 年

/ . .

C 60384-1 2008

1:

1

C 60384-14 3

005

14

14

B/ 5169.5-1997 (I

C 60695-2-2:1991)

2:

2: -

2

2

B/ 2693-2001 (I

C 60384-1 1999)

-

1:

1

B/ 2828.1-2003 (I

2859-1:1999)

-

1:

(A) -

1

(A)

B/ 2471-1995 (I

C 63:1963)

B/ 2691-1994 (I

C 62:1992)

/ 11363-2006

/ 11364-2006

/ 11365-2006

2011/65/ (2.0)

2002/96/ C ()

94/62/ C 2005/20/ C

C

94/62/ C 20

1994

1994 12 20

94/62/ C

1907/2006(AC)

, ,A

C

(151)