

, \* % 7 0 R G X O H V

9 & ( 6 9  
, & \$

\$ S S O L F D W L R Q V

g 0 R W R U ' U L Y H U V

g \$ & D Q G ' & V H U Y R G U L Y H D P S O L I L H U

g 8 3 6 8 Q L Q W H U U X S W L E O H 3 R Z H U 6 X S S O

) H D W X U H V

g / R Z V Z L W F K L Q J O R V V H V

g / R Z F Y V D Z V L W K S R V L V D W X H U W H F R S H I L F L H Q W

g , Q F O X G L Q J I D F R W H U M R D W W L H S D U D O O H O

g / R Z L Q G X F W D Q F H F D V H

g + L J K V K R U W F L U F X L W F D S D E L O L W \ X

g , V R O D W H G K H D W V L Q N X V L Q J ' % & W H F K

g 0 D [ L P X P M X Q F W L R Q W H P S H U D W X U H

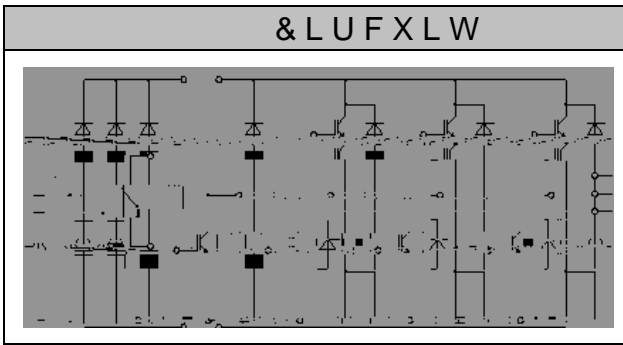

, \* % 7 L Q Y H U W H U  
\$ E V R O X W H 0 D [ L P X P 5 D W L Q J V

3 D U D P H W H U	6 \ P E R O	& R Q G L W L R Q V	9 D O X H
& R O O H F W R U ( P L W W H U 9 R O W D J H	9 - ( 9 & , P \$ 9 y 7 -		9
& R Q W L Q X R X V & R O O H F W R U & X U J H Q W	7 <sub>F</sub> - 7 <sub>Y M P D [</sub> - ,		\$
5 H S H W L W L Y H 3 H D N & R O O H F W R U	R <sub>60</sub> & X U J H Q W P V	,	\$
* D W H ( P L W W H U 9 R O W D J H	*( 6 7 <sub>Y M</sub> - 9	"	9
7 R W D O 3 R Z H U ' L V V L S D W L R Q	W R W 7 <sub>F</sub> - 3 7 <sub>Y M P D [</sub> -		:



0 \*

3

3

RoHS  
COMPLIANT

, \*%7 LQYHUWHU  
&KDUDFWHULVWLF YDOXHV

3DUDPHWHU	6\PERO	&RQGLWLRQV	9DOXH			8QLW
			0LQ	7\	0D[	
*DWH HPLWWHU 7KUHVKROG 9RQWDJH	9&( &	PS97 -				9
&ROOHFWRU (PLWWHU &XW RII&XUJH	9&( &XUJH	9 9( 9 7M -				P\$
&ROOHFWRU (PLWWHU 6DWXUDWLRQ 9ROWDJH	9&( VDW	, F \$ .9 9 7M -				9
		, F \$ .9 9 7M -				
		, F \$ .9 9 7M -				
*DWH &KDUJH	.	4				X&
,QSXW &DSDFLWDQFH	LHV	9&( 9 9				
5HYHUVH 7UDQVIHU &DSDFLWDQFH	QFH	1 0+] 7M - &				Q)
*DWH (PLWWHU OHDNDJH FXUUHQW	FXUUHQW	9&( 9 .9 9 .7M -				Q\$
7XUQ RQ 'HOD\ 7LPH	G RQ	W				QV
5LVH 7LPH	U	W & \$				QV
7XUQ RII 'HOD\ 7LPH	G RII	9&(W 9				QV
)DOO 7LPH	I	9-( " 9				QV
(QHUJ\ 'LVVLSDWLRQ 'XULQJ 7XUQ RQ 7LPH	RQ	W 5.				P-
(QHUJ\ 'LVVLSDWLRQ 'XULQJ 7XUQ RII 7LPH	RII	W 5.				P-
7XUQ RQ 'HOD\ 7LPH	G RQ	W				QV
5LVH 7LPH	U	W & \$				QV
7XUQ RII 'HOD\ 7LPH	G RII	9&(W 9				QV
)DOO 7LPH	I	9-( " 9				QV
(QHUJ\ 'LVVLSDWLRQ 'XULQJ 7XUQ RQ 7LPH	RQ	W 5.				P-
(QHUJ\ 'LVVLSDWLRQ 'XULQJ 7XUQ RII 7LPH	RII	W 5.				P-
6& 'DWD	VF ,	7S" XV .9 9 7M - 9FF 9 9(0" 9				\$



'LRGH LQYHUWHU  
\$EVROXWH 0D[LPXP 5DWLQJV

3DUDPHWHU	6\PERO	&RQGLWLRQV	9DOXH
5HSHWLWLYH 3HDN 5HYHUVH 9ROWDJH	95 9	95 9	9
&RQWLQXRXV '& )RUZDUG &XUHQW			\$
5HSHWLWLYH 3HDN )RUZDUG &XUHQW			\$
,W YDOXH	W	95 9 PV 95 9	\$ V

&KDUDFWHULVWLF YDOXHV

3DUDPHWHU	6\PERO	&RQGLWLRQV	9DOXH			8QLW
			0LQ	7\	0D[	
)RUZDUG 9ROWDJH	)	) \$ 7M -				9
5HFRYHUHG &KDUJH	UU	) 4 \$				X&
3HDN 5HYHUVH 5HFRYHU\ &XUHQW	95 9	95 9 GLGW \$' XV				\$
5HYHUVH 5HFRYHU\ (QHUJ\	UHF	7YM - (				P-
5HFRYHUHG &KDUJH	UU	) 4 \$				X&
3HDN 5HYHUVH 5HFRYHU\ &XUHQW	95 9	95 9 GLGW \$' XV				\$
5HYHUVH 5HFRYHU\ (QHUJ\	UHF	7YM - (				P-



0 \*

3

3

RoHS COMPLIANT

, \*%7 EUDNH FKRSSHU \$EVROXWH 0D[LPXP 5DWLQJV

3DUDPHWHU	6\PERO	&RQGLWLRQV	9DOXH
&ROOHFWRU (PLWWHU 9ROWDJH	9( 9 & P\$9,7M -		9
&RQWLQXRXV &ROOHFWRU &XUJHQW	7F - 7MPD[ - ,		\$
5HSHWLWLYH 3HDN &ROOHFWRU &XUJHQW	7F - 7MPD[ - ,		\$
*DWH (PLWWHU 9ROWDJH	7YM - 9	"	9
7RWDO 3RZHU 'LVVLSDWLRQ	7F - 7MPD[ -		:

&KDUDFWHULVWLF YDOXHV

3DUDPHWHU	6\PERO	&RQGLWLRQV	9DOXH			8QLW
			0LQ	7\S	0D[	
*DWH HPLWWHU 7KUHVKROG 9ROWDJH	9( 9 & P\$9,7M -					9
&ROOHFWRU (PLWWHU &XWRIL &XUJHQW	9( 9 9 7M -					P\$
&ROOHFWRU (PLWWHU 6DWXUDWLRQ 9ROWDJH	9( VDW	,F \$ .9 9 7M -				9
		,F \$ .9 9 7M -				
		,F \$ .9 9 7M -				
*DWH &KDUJH	.	4				X&
,QSW &DSDFLWDQFH	LHV	9( 9 9				Q)
5HYHUVH 7UDQVIHU &DSDFLWDQFH	9( 9 9	1 0+] YM - &				Q)
*DWH (PLWWHU OHDNDJH FXUJHQW	9( 9 9 9 7M -					Q\$
7XUQ RQ 'HOD\ 7LPH	G RQ	W				QV
5LVH 7LPH	U	W & \$				QV
7XUQ RII 'HOD\ 7LPH	G RII	9( W 9				QV
)DOO 7LPH	I	9( " 9				QV
(QHUJ\ 'LVVLSDWLRQ 'XULQJ 7XUQ RQ 7LPH	9( 9 9 9 7M -					P-
(QHUJ\ 'LVVLSDWLRQ 'XULQJ 7XUQ RII 7LPH	9( 9 9 9 7M -					P-



0 \*

3

3

RoHS  
COMPLIANT

7XUQ RQ 'HOD\ 7LPH	G RQ	W				Q V
5LVH 7LPH	U	W & \$				Q V
7XUQ RII 'HOD\ 7LPH	G RII	9&(W 9				Q V
)DOO 7LPH	I	9.( " 9				Q V
(QHUJ\ 'LVVLSDWLRQ 'XULQJ 7XUQ RQ 7LPH		W.				P-
(QHUJ\ 'LVVLSDWLRQ 'XULQJ 7XUQ RII 7LPH		7				P-

6 & 'DWD

VF , 7s" XV.9 9 7M -  
9FF 9 9



'LRGH 5HFWLILHU  
\$EVROXWH 0D[LPXP 5DWLQJV

3DUDPHWHU	6\PERO	&RQGLWLRQV	9DOXH
5HSHWLWLYH 3HDN 5HYHUVH 9ROWDJH - 9	950		9
\$YHUDJH RXWSXW &XUUHQW + ] VLQH ZDYH	) \$9	7F -	\$
0D[LPXP 506 &XUUHQW DW 5HFWLILHU 2XWSXW ,	5060		\$
6XUJH )RUZDUG &XUUHQW	)60	95 \$W ,PV 7 -	\$
,W YDOXH	W	, 95 \$W PV 7 -	\$V

&KDUDFWHULVWLF YDOXHV

3DUDPHWHU	6\PERO	&RQGLWLRQV	9DOXH			8QLW
			0LQ	7\ \$	0D[	
'LRGH )RUZDUG 9ROWDJH	)	) \$ 79 -				9
5HYHUVH &XUUHQW	5	7M , - \$ 9				P \$

17 & 7KHUPLVWRU  
&KDUDFWHULVWLF YDOXHV

3DUDPHWHU	6\PERO	&RQGLWLRQV	9DOXH			8QLW
			0LQ	7\ \$	0D[	
5DWHG 5HVLVWDQFH		5				
'HYLDWLRQ RI 5		5 5 5 7				
3RZHU 'LVVLSDWLRQ		3				P :
% YDOXH	%	5 H[S >5% 7 . @				



0 \*

3

3

RoHS  
COMPLIANT

0 R G X @ \ 0 R G X @ \ ! , p 5 1 # / 0 ~ 1 & , À ! y p G X @ À " H , , b A Q % b b A " ! ! ! ... Q ç Â V ! , , , b 2 \$ b Ä • Q Œ B G e ! ' Ä —



0 \*

3

3

RoHS  
COMPLIANT

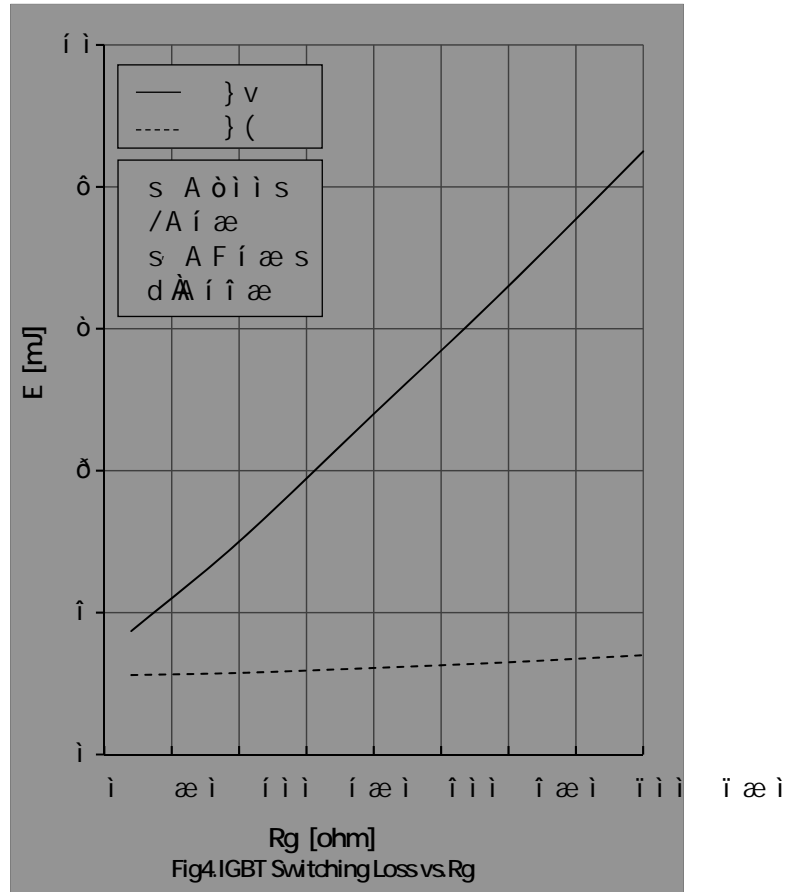
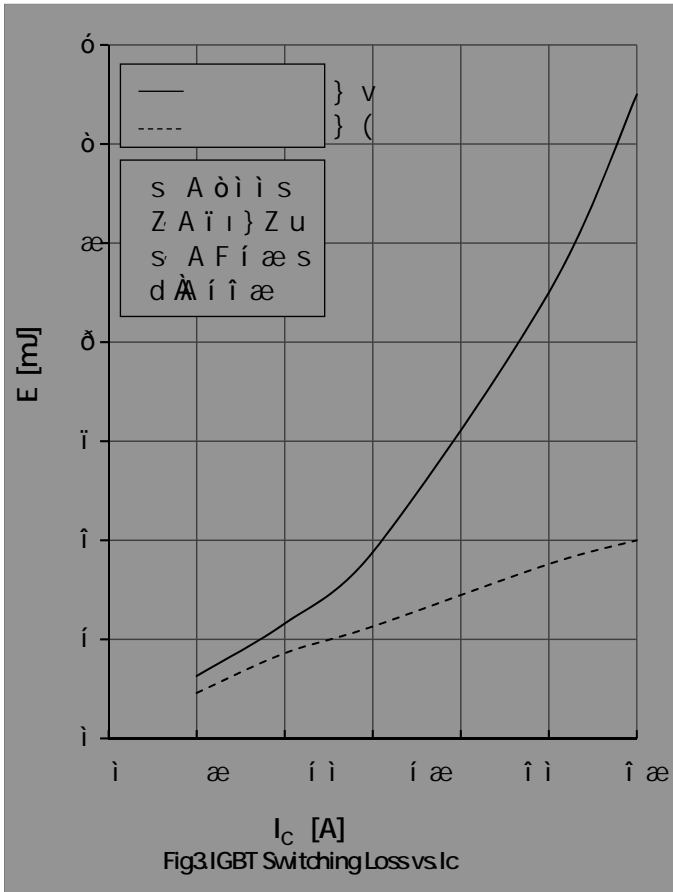
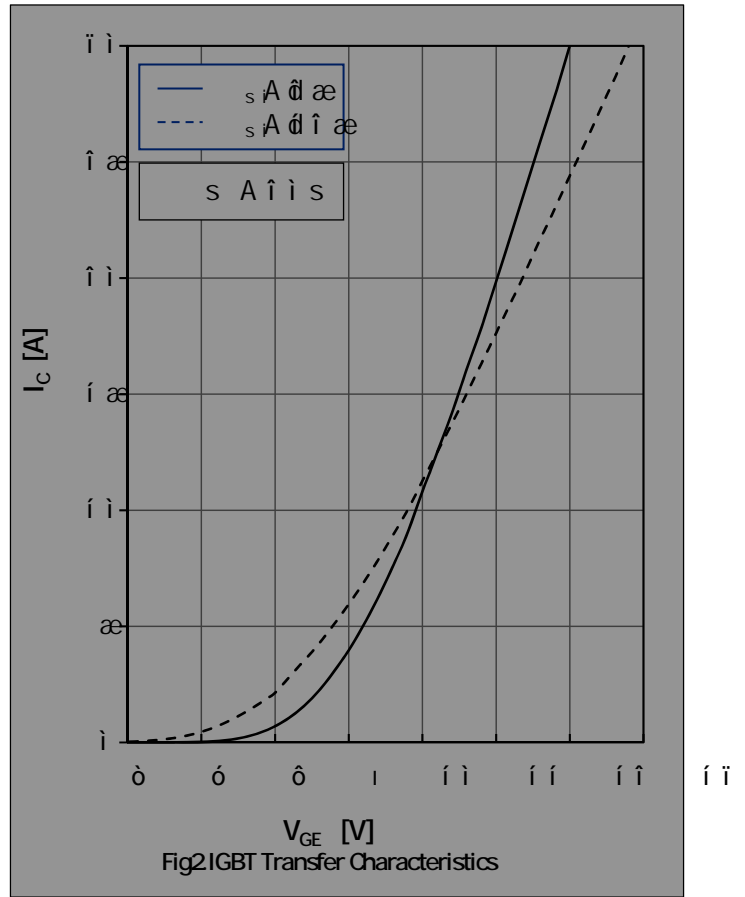
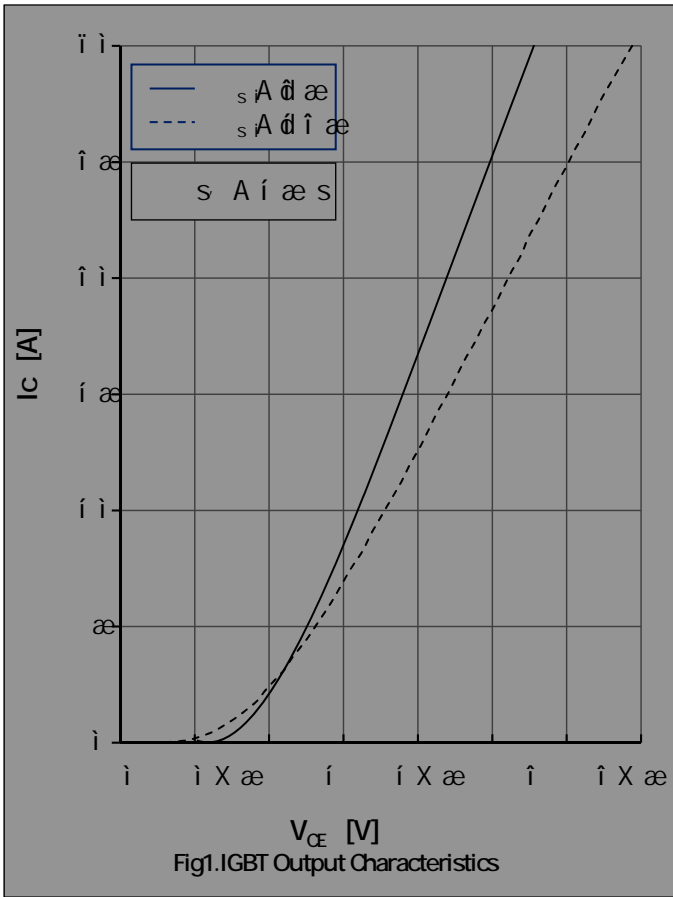





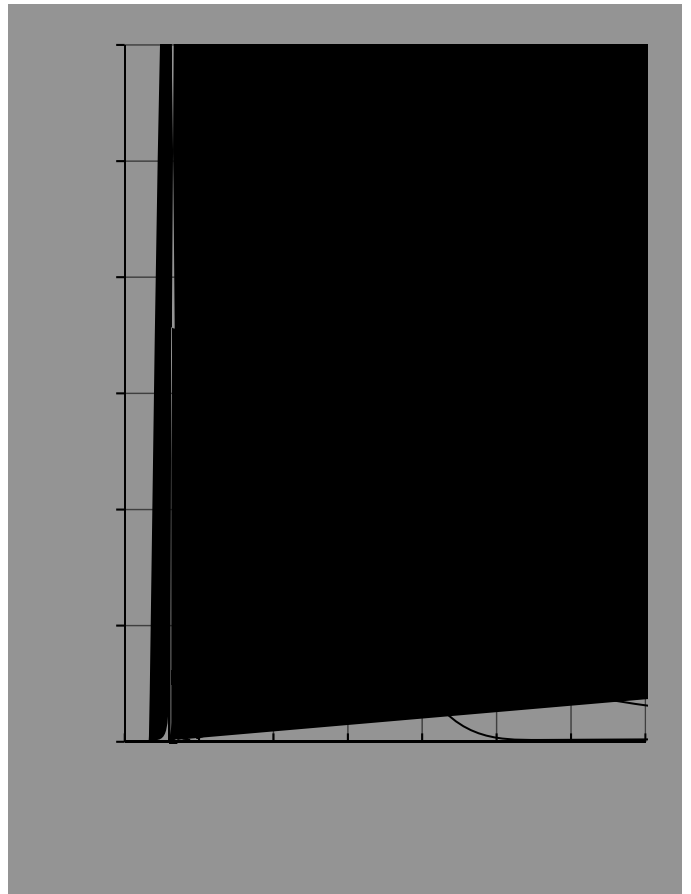
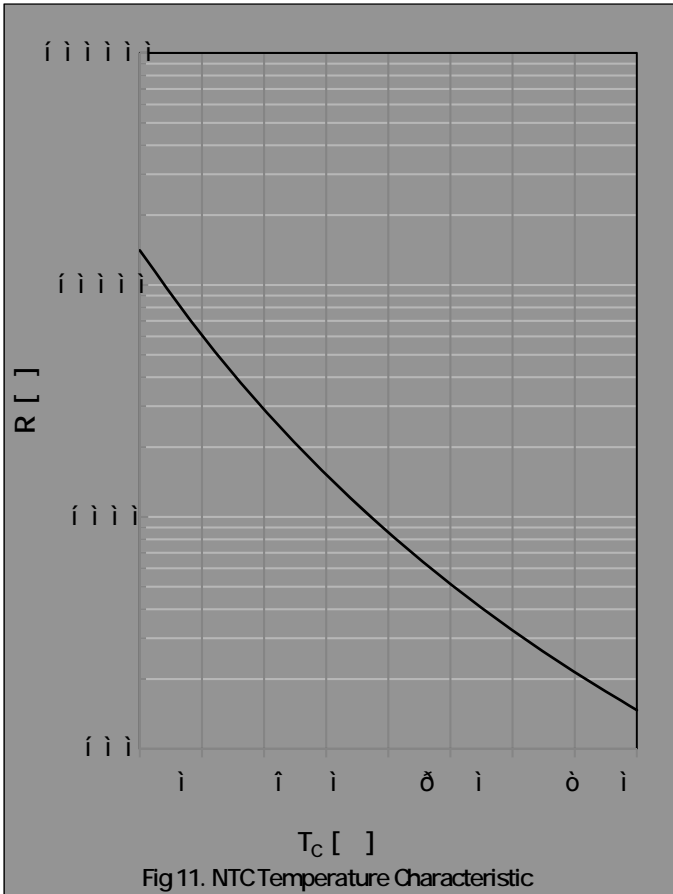
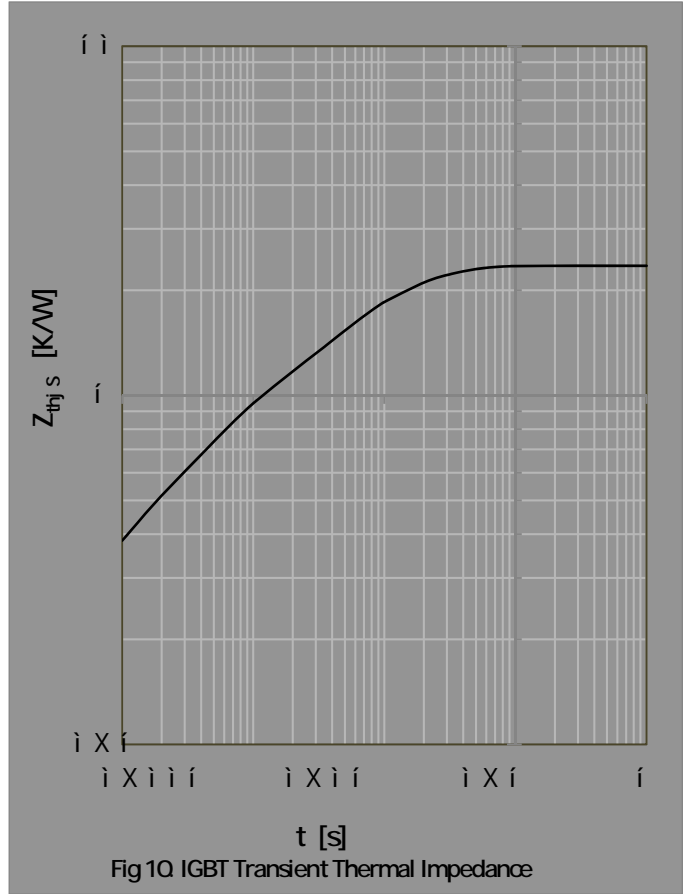
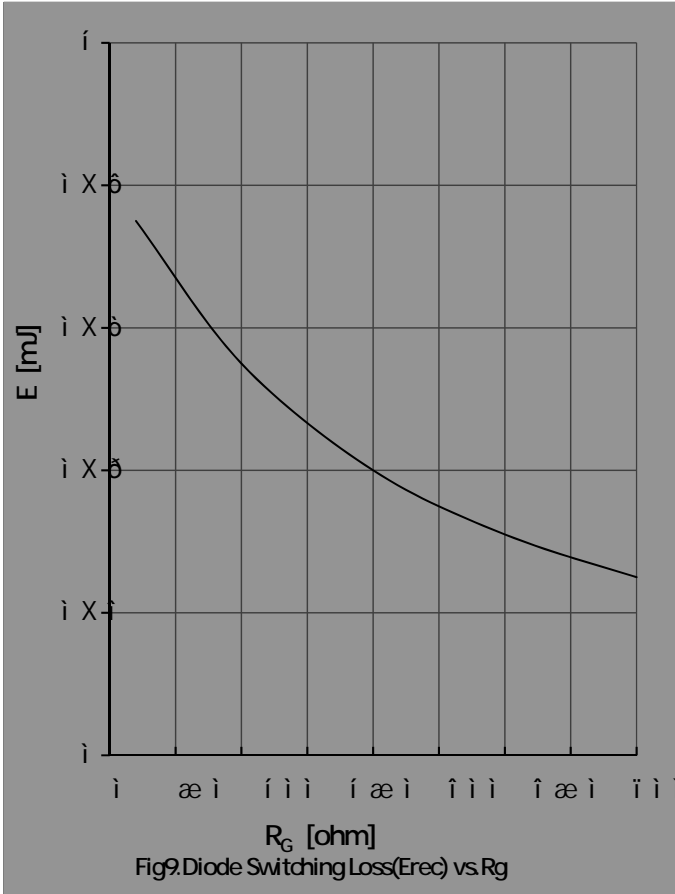



0 \*

3

3

RoHS  
COMPLIANT

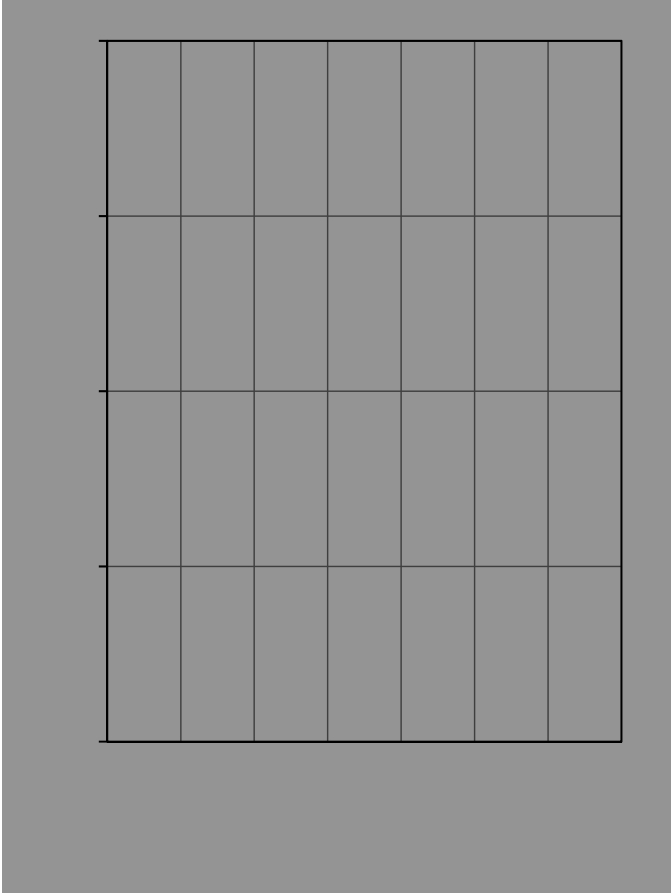



& LUFXLW 'LDJUDP

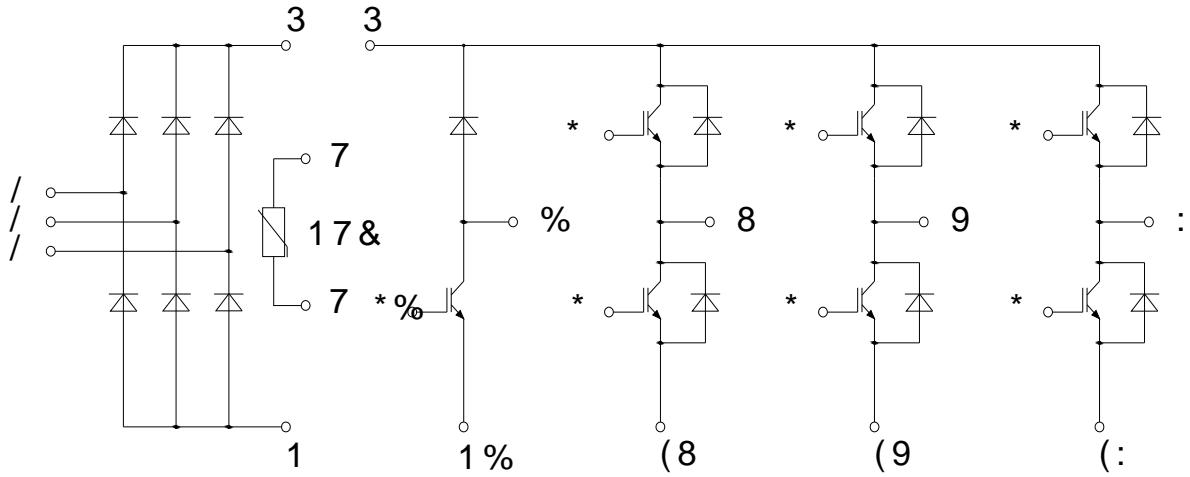

3DFNDJH 'LPHQVLRQV

