

Features

- Fast switching

PINNING

PIN	DESCRIPTION
1	Cathode
2	Anode

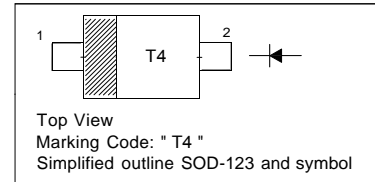

Absolute Maximum Ratings ($T_a = 25\text{ }^\circ\text{C}$)

Parameter	Symbol	Value	Unit
Peak Reverse Voltage	V_{RM}	100	V
Reverse Voltage	V_R	75	V
Average Rectified Forward Current	$I_{F(AV)}$	150	mA
Non-repetitive Peak Forward Surge Current at $t = 1\text{ }s$	I_{FSM}	2	A
Power Dissipation	P_{tot}	400	mW
Thermal Resistance from Junction to Ambient Air	R_{JA}	312	$^\circ\text{C}/\text{W}$
Junction Temperature	T_j	150	$^\circ\text{C}$
Storage Temperature Range	T_{stg}	- 65 to + 150	$^\circ\text{C}$

Characteristics at $T_a = 25\text{ }^\circ\text{C}$

Parameter	Symbol	Min.	Max.	Unit
Reverse Breakdown Voltage	$V_{(BR)R}$	75	-	V
Forward Voltage at $I_F = 1\text{ mA}$ at $I_F = 10\text{ mA}$ at $I_F = 50\text{ mA}$ at $I_F = 150\text{ mA}$	V_F	- - - -	0.715 0.855 1 1.25	V
Peak Reverse Current at $V_R = 75\text{ V}$ at $V_R = 20\text{ V}$ at $V_R = 75\text{ V}, T_J = 150\text{ }^\circ\text{C}$ at $V_R = 25\text{ V}, T_J = 150\text{ }^\circ\text{C}$	I_R	- - - -	1 25 50 30	μA nA μA μA
Total Capacitance at $V_R = 0\text{ V}, f = 1\text{ MHz}$	C_T	-	2	pF
Reverse Recovery Time at $I_{rr} = 0.1 \times I_R, I_F = I_R = 10\text{ mA}, R_L = 100$	t_{rr}	-	4	ns

Typical Characteristics

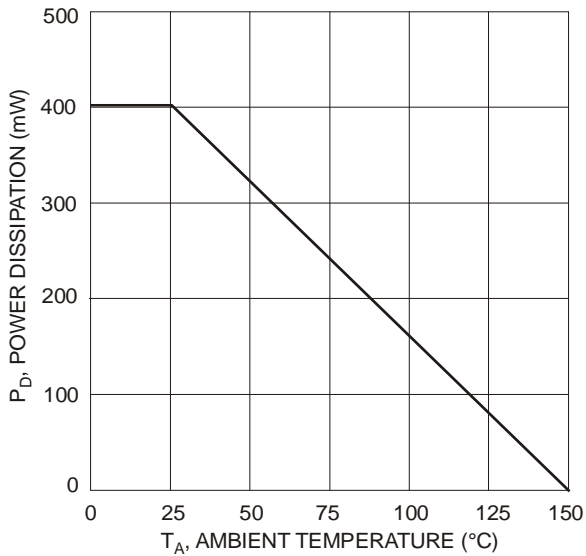

Fig. 1 Power Derating Curve

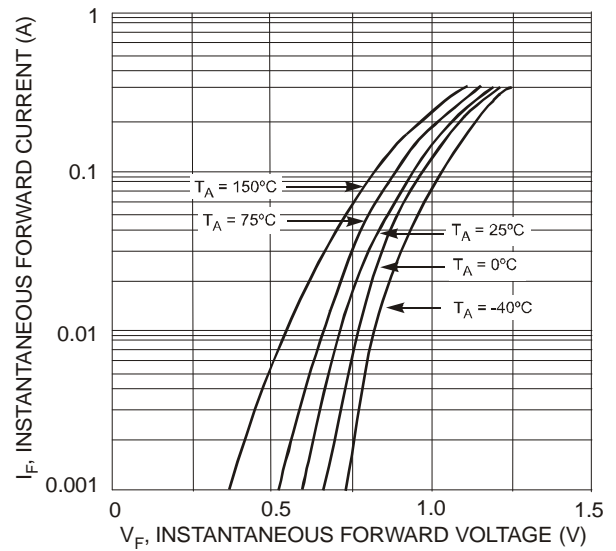

Fig. 2 Typical Forward Characteristics

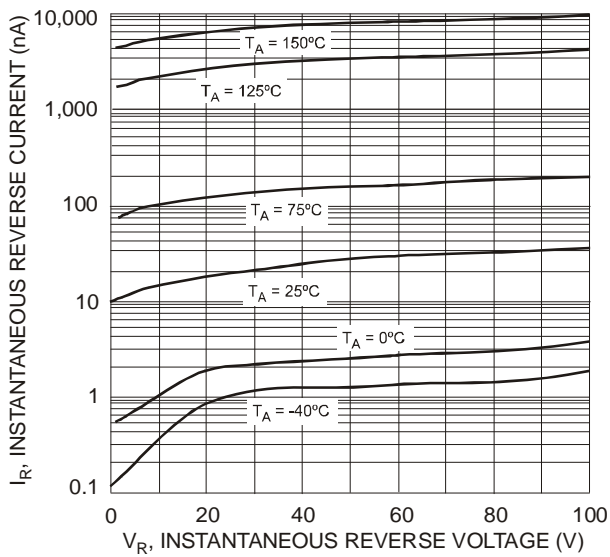

Fig. 3 Typical Reverse Characteristics

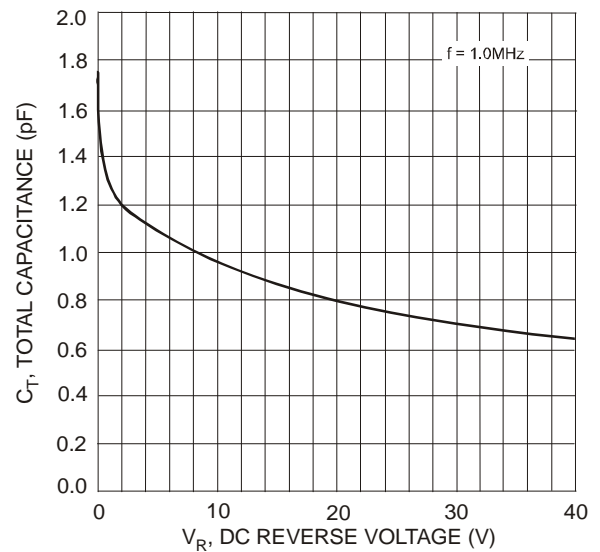

Fig. 4 Total Capacitance vs. Reverse Voltage



1N4148W

Silicon Epitaxial Planar Switching Diode

PACKAGE OUTLINE

Plastic surface mounted package; 2 leads

SOD-123

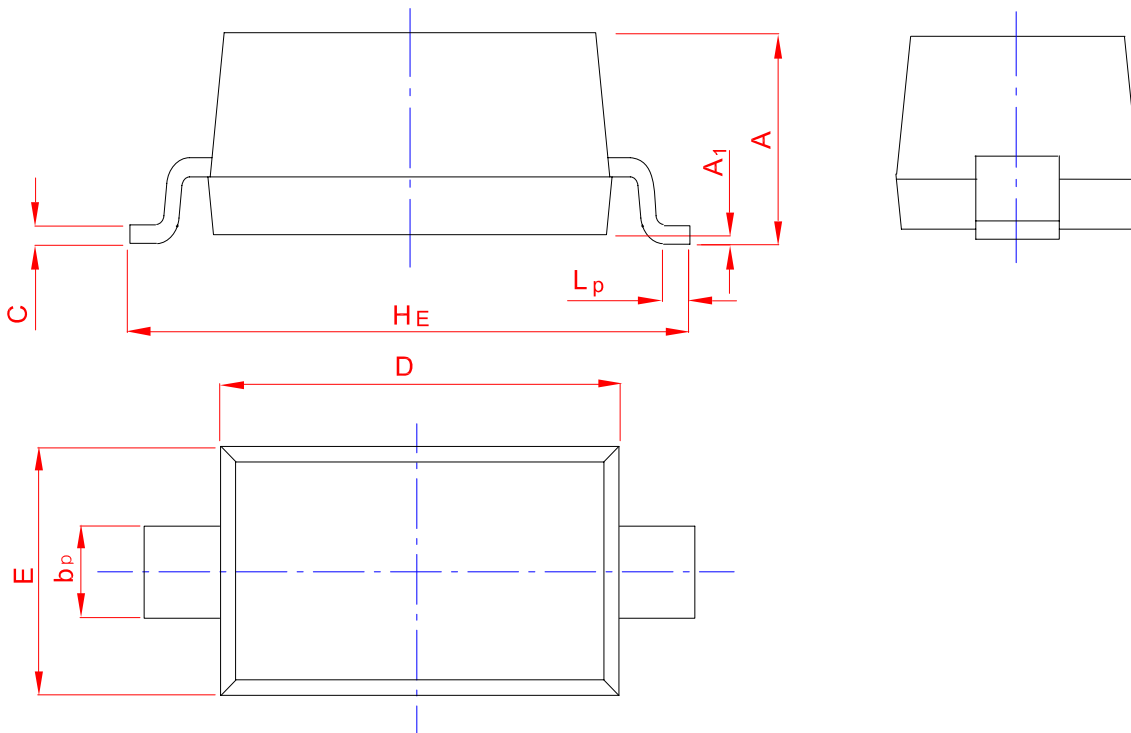
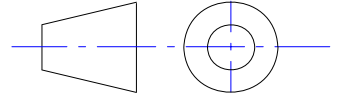

UNIT	A	b_p	C	D	E	H_E	A_1	L_p
mm	1.20	0.60	0.135	2.75	1.65	3.85	0.10	0.50
	0.90	0.50	0.100	2.55	1.55	3.55	0.01	0.20