



# 深圳市弗瑞鑫电子有限公司

## 规格承认书

—  
\_\_\_\_\_  
\_\_\_\_\_

prepare	
check	
approve	



TRX电容一级代理商

深圳市弗瑞鑫电子有限公司

Add:深圳市宝安区西乡大道302号金源商务大厦B座3楼

Tel:0755-29563634

Fax:0755-27447020



	2 2 . .		
	/		/
	/		/

	2 2 . .		
	/		/
	/		/

1. /

$\overline{\text{①}}$   $\overline{\text{②}}$   $\overline{\text{③}}$   $\overline{\text{④}}$   $\overline{\text{⑤}}$   $\overline{\text{⑥}}$

①

	2 2 . .		
	/		/
	/		/

3. /



4. /

5. /

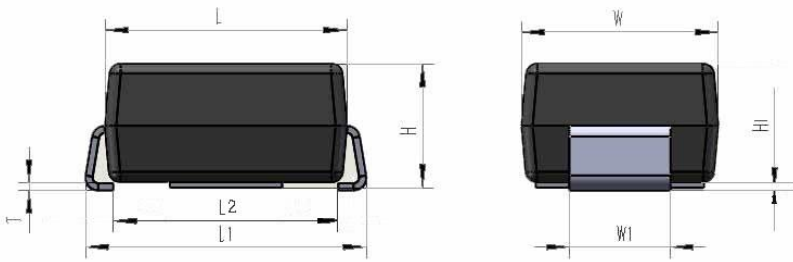

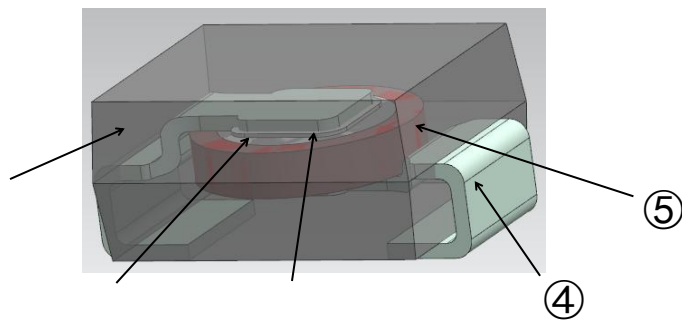
①		
②		
③		
④		
⑤		

2  
2 ..

/

/

/

	2 2 . .		
	/		/
	/		/

/

°  
°C

°

°

°

/

7. /



	2 2 . .		
	/		/
	/		/



 <b>TRX</b> 专注电容器廿年	2		
	2 . .		
	/		/
	/		/



Diagram illustrating the test setup:

- Approximately 8mm
- burner
- 45°
- flame
- 200 ± 5mm
- Test specimen
- Tissue paper

8. /

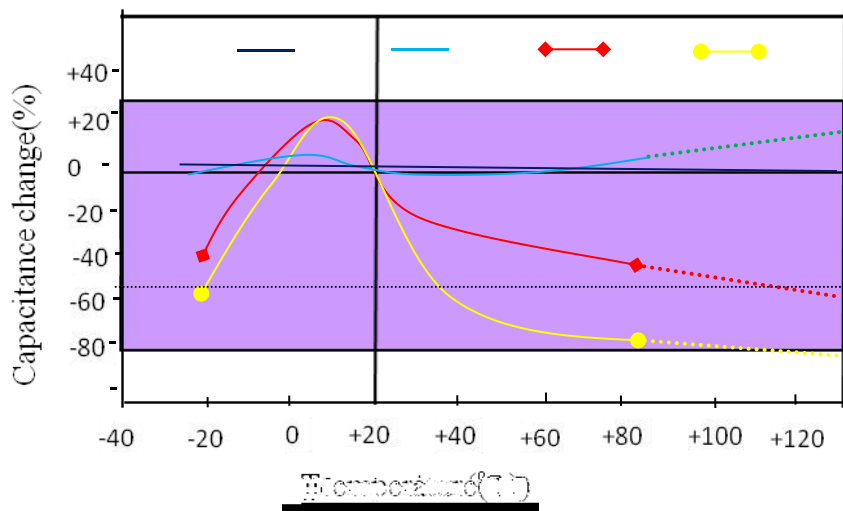

 <b>TRX</b> 专注电容器廿年		<b>2</b>		
	/		/	
/			/	

9. /







10. /  
(1)

(2)

/  
/  
(3)

(4)

11. /  
/

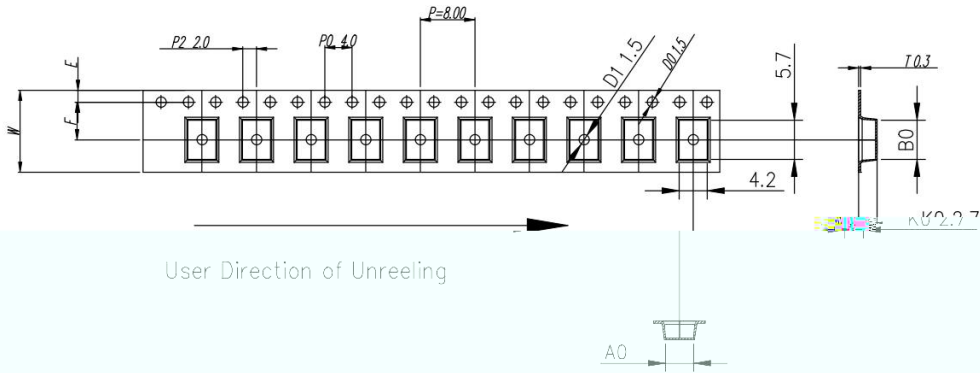

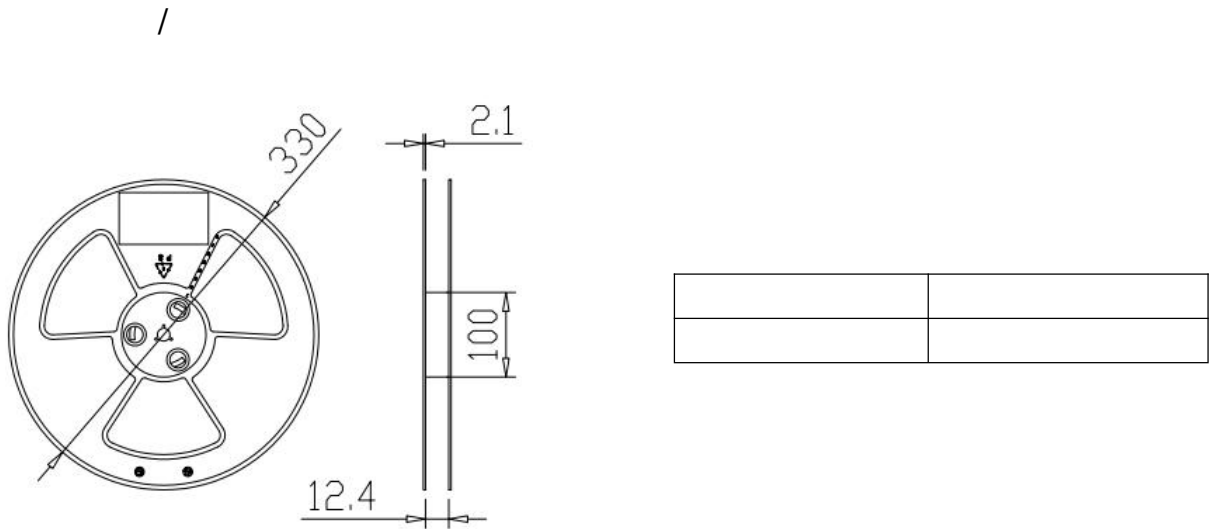

ITEM	W	A0	B0	K1	K0	P	F	E	D0	D1	P0	P2	T
DIM	12.0 $\pm 0.30$	4.2 $\pm 0.10$	5.70 $\pm 0.10$	--	2.70 $\pm 0.10$	8.00 $\pm 0.10$	5.50 $\pm 0.10$	1.75 $\pm 0.10$	$\phi 1.5$ $\pm 0.05$	$\phi 1.5$ $\pm 0.10$	4.0 $\pm 0.10$	2.0 $\pm 0.10$	0.30 $\pm 0.05$
ALTERNATE													

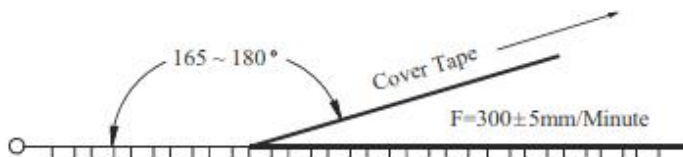

/

Item	Data	Remark
Cover tape adhesion	10 ~ 100g	Carrier tape and cover tape open angle 165 ~ 180° F=300±5mm/minute



 <b>TRX</b> 专注电容器廿年	2 2 . .			
	/		/	
	/		/	

/ -

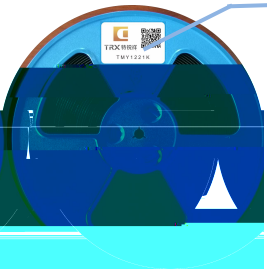

标签



料号

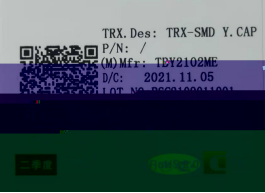

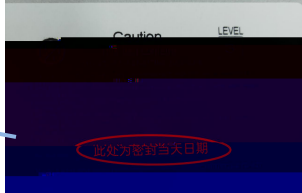

/ -





图示 /



图示 /



图示 /

--	--	--	--

/ :



/



/





--	--



	2 2 . .		
	/		/
	/		/

12. /

①

②