

深圳市弗瑞鑫电子有限公司

规格承认书

—

prepare	
check	
approve	



TRX电容一级代理商

深圳市弗瑞鑫电子有限公司

Add: 深圳市宝安区西乡大道302号金源商务大厦B座3楼

Tel: 0755-29563634

Fax: 0755-27447020

SMD- 2

SMD 2 . .

/N

-3-082

/D

2021-11-15

/E

A1

/P

P 3 18

 TRX 专注电容器廿年	SMD- 2			
	SMD 2 . .			
	/N	-3-082	/D	2021-11-15
	/E	A1	/P	P 4 18

/CON EN

1.	P	N	-----	5
2.	P		-----	5-6
3.	D		-----	6
4.	C		-----	7
5.	P		-----	7-8
6.			-----	8-9
7.	P		-----	9-14
8.	C		-----	14
9.	C		-----	15
10.			-----	15
11.	P	P	-----	16-17
12.	A		-----	18

 TRX 专注电容器廿年	SMD- 2 SMD 2 . .			
	/N	-3-082	/D	2021-11-15
	/E	A1	/P	P 5 18

1. /P N

T B 2 102 M E
 ① ② ③ ④ ⑤ ⑥

N . C

E

B*

①

L ^{JW} 779.1885 0 TD[(R)]TJTJ 146.39(D)]TJ 1

 TRX 专注电容器廿年	SMD- 2		
	SMD 2 . .		
	/N	-3-082	/D
/E	A1	/P	P 6 18

3. /D



		2020	M	1	01	1	01	16	16
		2021	N	2	02	2	02	17	17
2010	A	2022	P	3	03	3	03	18	18
2011	B	2023		4	04	4	04	19	19
2012	C	2024		5	05	5	05	20	20
2013	D	2025		6	06	6	06	21	21
2014	E	2026		7	07	7	07	22	22
2015	F	2027		8	08	8	08	23	23
2016	H	2028		9	09	9	09	24	24
2017	J	2029		10	10	10	10		

 TRX 专注电容器廿年	SMD- 2			
	SMD 2 . .			
	/N	-3-082	/D	2021-11-15
/E	A1	/P	P 7 18	

4. /C

C		C	C
L/C L	L/C A 60384-14	E315719	AC300 (. . .)
C C	GB/ 6346.14-2015	C C20001280609	AC300 (. . .)
ENEC	EN 60384-14:2013/A1:2016	ENEC-03177	AC300 (. . .)
KC	K60384-14	H 03034-21003A	AC250 (. . .)

5. /P

5.1 /P D

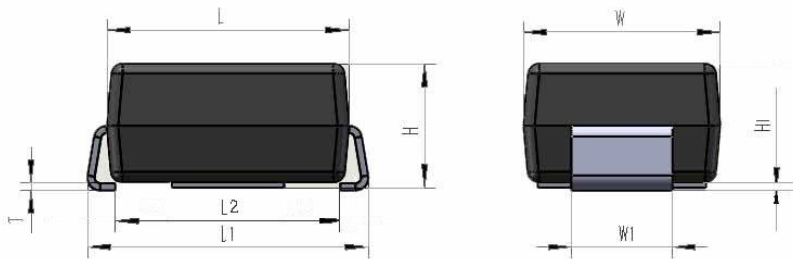

P		D		()	
L	4.3 0.1			3.5 0.3	
L1	5.0 0.1	L2		4.0 0.1	
H	2.2 0.1	1		1.8 0.05	
H1	0.1 0.05			0.13 0.02	

5.2 /P

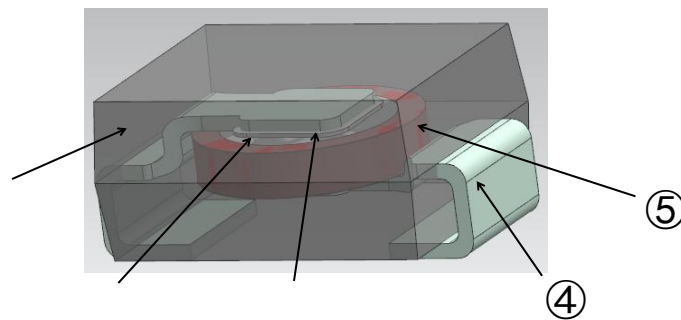

N .	P	M
①	C	E (L94 -0) (L94 -0)
②	E	/ /C
③		-P -A -P -A
④	L P	
⑤	D	C

 TRX 专注电容器廿年	SMD- 2		
	SMD 2 . .		
	/N	-3-082	/D
/E	A1	/P	P 8 18

5.3 / P

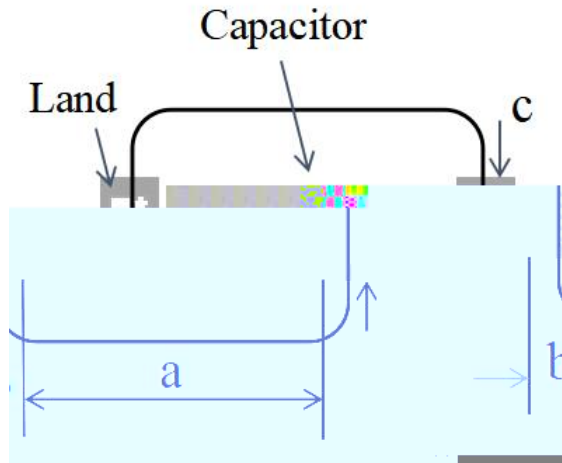

P D	()	()	()
4.3 3.5	4.0	2.2 0.1	3.2 0.1

6. /S

6.1 /

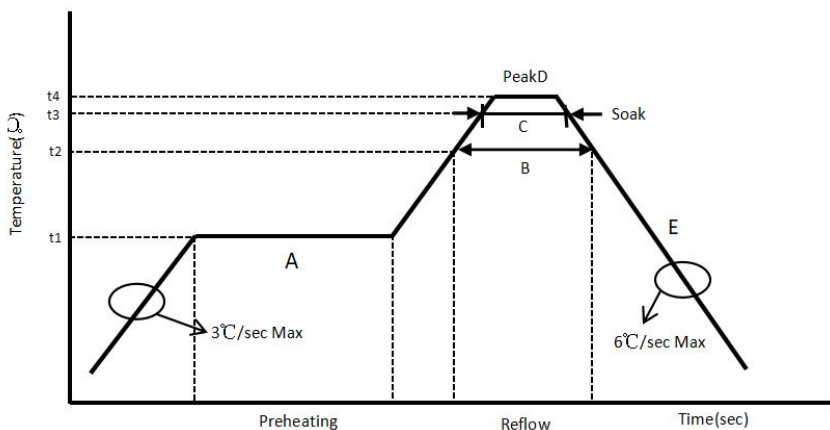
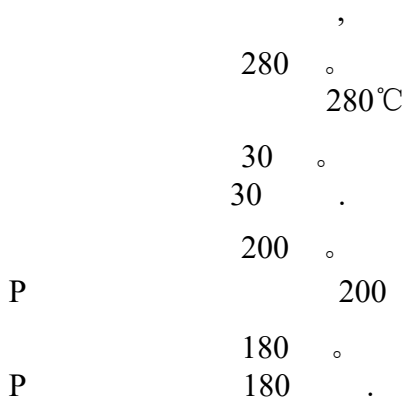

1	175 25	P	A A	120 60
2	215 10		B	110 20%
3	230 10		C C	30 20%
4	275 5	P	D D	20 10

 TRX 专注电容器廿年	SMD- 2			
	SMD 2 . .			
	/N	-3-082	/D	2021-11-15
	/E	A1	/P	P 9 18

6.2 /F

280 °
280°C

30 °
30

200 °
200

P 200

180 °
180

P 180

6.3 / I
PCB/P B

PCB/P B,

400
- 400

50
50

5
5

7. /P

NO	I		
1	A	N L L	
2	D	5.1 5.1	

 TRX 专注电容器廿年	SMD- 2		
	SMD 2 . .		
	/N	-3-082	/D
/E	A1	/P	P 10 18

NO	I	
----	---	--

3

ANSI J 1 0 TD[(H) J 120 0 TD[(Q)]TJ]TJ 67.1885 0 TD[(K)]TJ 117.594 0 TD[(H)N i -8363.97 -125]TJ 117.594 0

 TRX 专注电容器廿年	SMD- 2			
	SMD 2 . .			
	/N	-3-082	/D	2021-11-15
	/E	A1	/P	P 11 18

NO	I			
8				150 180 C 90 30 P 150 180 C 90 30 . / : 230 C-260 C / : 60± 15 . / :4 15--35 45--75% H 24 2 L 15-35 , 45-75% H 24 2 , .
			NO.3 P NO.3	
	C		L:± 10% 5P:± 10% 5 :± 20% 5 :± 20%	
	D.F.		L: 1.0% 5P: 2.5% 5 : 2.5% 5 : 2.5%	
	I .		NO.7 P NO.7	
9				(JI K 8101) (JI K 5902) () 25%) () I (JI K 8101) (JI K 5902) (25%)) . () I 2 0.5 2 0.5 . : 245 10 C
10			N	
			NO.3 P NO.3	: +125 3
	C		L:± 10% 5P: 10% 5 : 20% 5 : 20%	: -40 3 / :5
	D.F.		L: 1.0% 5P: 2.5% 5 : 2.5% 5 : 2.5%	30 25 3 24 2
	I .		NO.7 P NO.7	C 24 2 25 3 .

 TRX 专注电容器廿年	SMD- 2			
	SMD 2 . .			
	/N	-3-082	/D	2021-11-15
	/E	A1	/P	P 12 18

NO	I			
11			C L:± 10% 5P: 10% 5 : 15% 5 : 15% DF 2.5%	F : 10 55 10H / :0.75 6 6 2 2
12	D ()		N	/ : 40 2 / : 95 3% H / : 21 : A (300) (300)
		C	$\Delta=(C -C_0)/C_0$ L Δ : 10% 5P Δ : 10% 5 Δ : 15% 5 Δ : 15%	
			NO.3 P NO.3	24 2 25 3 24 2
		I .	3000M	
13	E		N	/ : 125 3 /D : 1000+24 -0 510 AC 1.7 1000 0.1 : 510 AC 1.7 1000 . . . 0.1 . 47 5%
		C	$\Delta=(C -C_0)/C_0$ L Δ : 10% 5P Δ : 10% 5 Δ : 15% 5 Δ : 15%	
			NO.3 P NO.3	E 47 5%.
		I .	3000M	25 3 24 2 C 24 2

 TRX 专注电容器廿年	SMD- 2			
	SMD 2 . .			
	/N	-3-082	/D	2021-11-15
/E	A1	/P	P 14 18	

NO	I		
16	C	N NO.3 NO.7 P N .3 N .7	$30 \pm 5\%$ $70 \pm 5\%$ $70 \pm 5\%$ $30 \pm 5\%$ / : 23 5 5 ± 0.5 $5 0.5$. / : 8
17			$30 \pm 5\%$ $70 \pm 5\%$ $70 \pm 5\%$ $30 \pm 5\%$ / : 23 5 5 ± 0.5 10 $5 0.5$ 10 .

8. /C

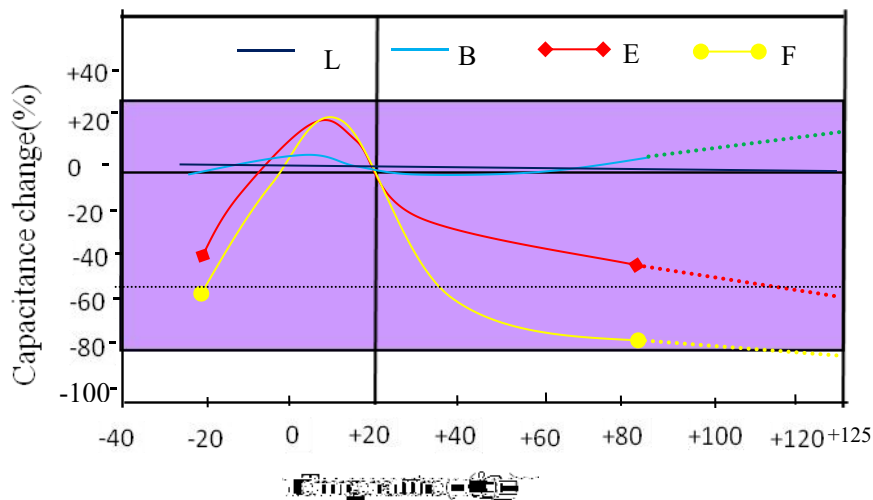

 TRX 专注电容器廿年	SMD- 2		
	SMD 2 . .		
	/N	-3-082	/D
/E	A1	/P	P 16 18

11. /P P

11.1 /D

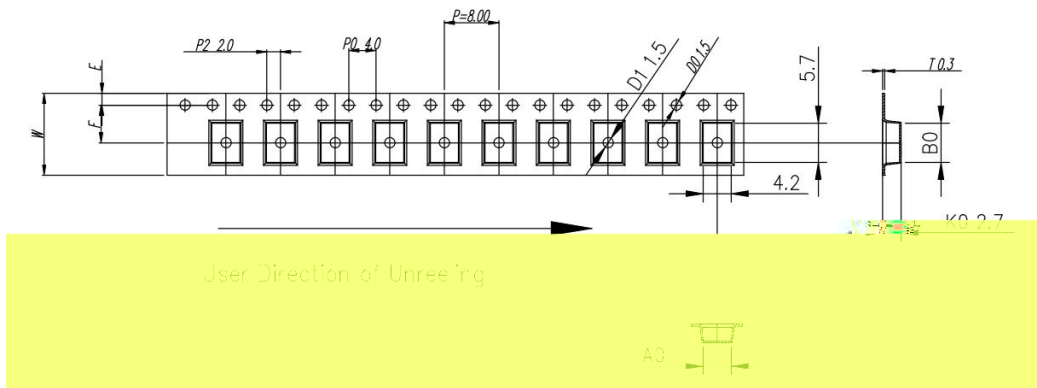

ITEM	W	A0	B0	K1	K0	P	F	E	D0	D1	P0	P2	T
DIM	12.0 ±0.30	4.7 ±0.10	5.70 ±0.10	-- ±0.10	2.70 ±0.10	8.00 ±0.10	5.50 ±0.10	1.75 ±0.10	∅1.5 ±0.00	∅1.5 ±0.10	4.0 ±0.10	2.0 ±0.10	0.30 ±0.05
ALTERNATE													

11.2 /D

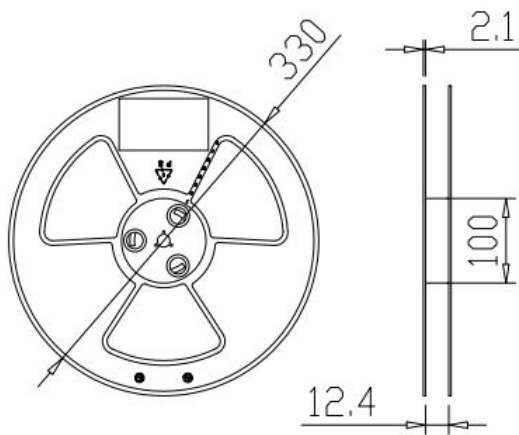

EEL	EEL I E
3000	13

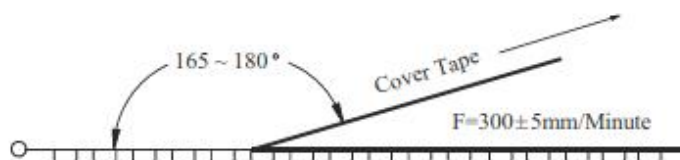

11.3 /P

Item	Data	Remark
Cover tape adhesion	10 ~ 100g	Carrier tape and cover tape open angle 165 ~ 180° F=300±5mm/minute





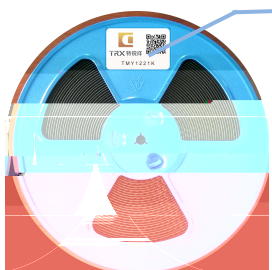

 TRX 专注电容器廿年	SMD- 2			
	SMD 2 . .			
	/N	-3-082	/D	2021-11-15
	/E	A1	/P	P 17 18



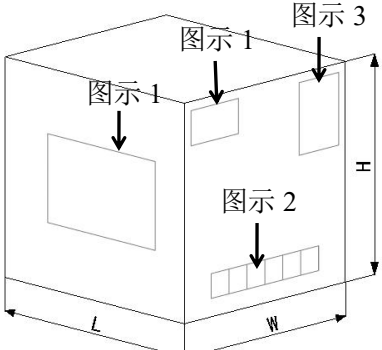

11.4 /P P

/ -	 <p>标签/L</p>	/I	
: 13 3.0KPC /	 <p>料号</p>	/I	.D
/P	/L	/H	P/N
			M
			D/C
			L .N
			PEC

/O -

			
图示 1/F 1	图示 2/F 2	图示 3/F 3	
D ()		O B	
L	H	45KPC	
355	358	10.0KG	

/P :

			
/O B	15 / /15 /B	(/ /) P (L/ /H) 1100*1100*90	(/ /) (L/ /H) 1100*1100*1600

1. " 5" 5 2. PALLE & APPING
 3.50 R :1. 5 ; 3.50 ; 4. N

	SMD- 2			
	SMD 2 . .			
	/N	-3-082	/D	2021-11-15
	/E	A1	/P	P 18 18

12. /A

①.

A

②.

PCB

PCB

PCB

C

(PCB)

PCB

PCB

E

\$ W