



深圳市弗瑞鑫电子有限公司

规格承认书

—

prepare	
check	
approve	



TRX电容一级代理商
深圳市弗瑞鑫电子有限公司

深圳市宝安区西乡大道302号金源商务大厦B座301
 0755-29563634
 0755-27447020



/ . .			

Capacity Range and T.C Differentiation Unit:pF

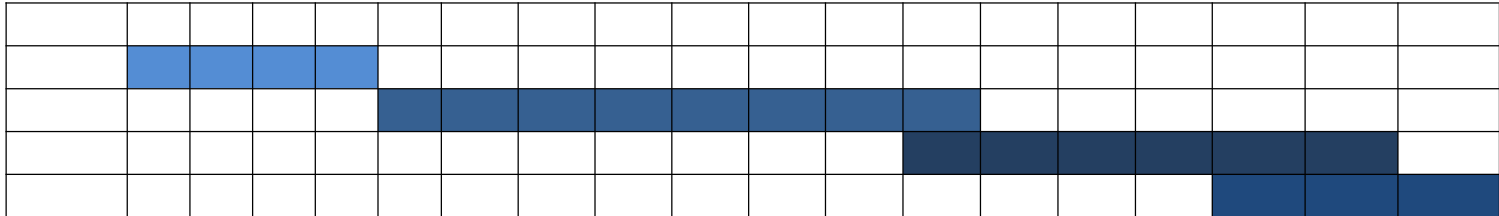

6	



/ . .			



	/ . .		

! /

!

--	--

	/ . .			



.

.

.

.

-

. .

-



	. .	000		00	0/0 0
		000			
	.		0	,	.
0	.				0
				+0 -0.	0
			. .	+0 -0.	0.
			% 0% 0% 0%	.	0.
			.0% . % . % . %	.	.
			. .		.
	.			0.	(0-0.) 0-0. , 0.

				+	
				-	
			..		0
			% 0% 0% 0%		0
			.0% . % . % . %		
			..		
				0	0
				0.	,
()				0	
			(- 0) / 0 %	000	00+ /-0 %
			..	00	00
			000 (- 0) / 0 0%		





\$i x LRSURS

.

.. ..

.. ..

/ . .			

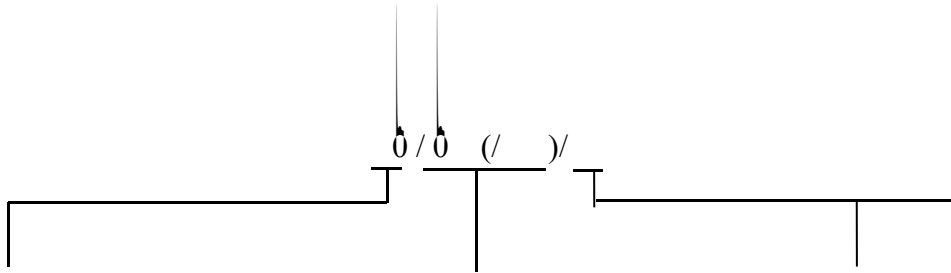

()
 ()
 ()

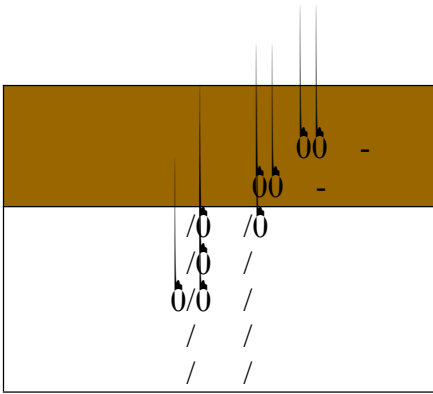

()	
0	-
0	-
0	- 0
0	-
0	- 0
00	0
0	+

()	
0	+
0	+
0 0	+ 0
0 0	+
0 0	+ 0
0 0	+
0 0	+ 0

()	
0	0
0	
00	

/ . .			

.0 0 / /
 0 / 00



	()
	00
	000
	000
	000
	000
	000
+ + + + () + + +	00
	00
	00
+ +	00
()	000

	/ . .			



PDF GENERATED BY PDF ELEMENTS (R) 105.5 Gray c(R)TJ 105.5 8.038 3 TD[(\)TJ 0 TD[4 0652 78. R32 R R R

|

/ . .			

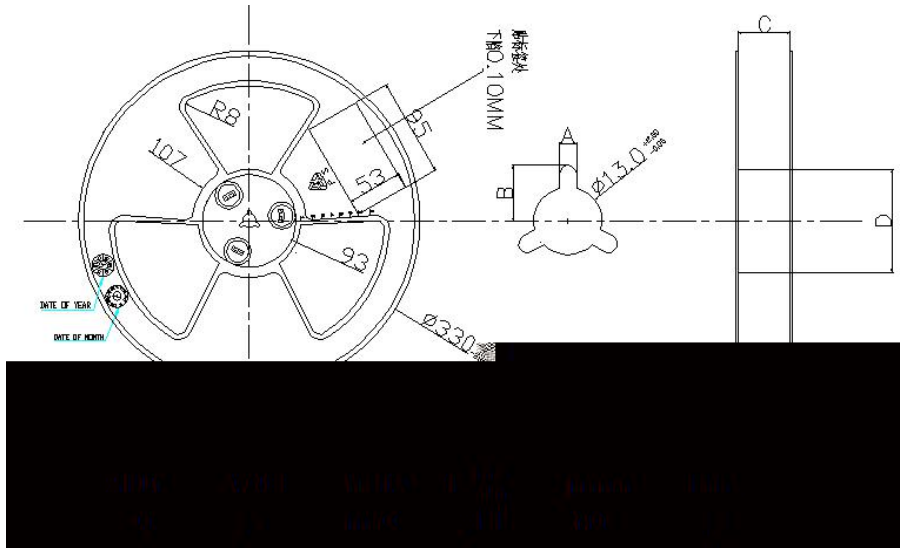
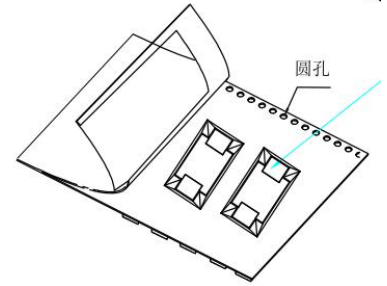
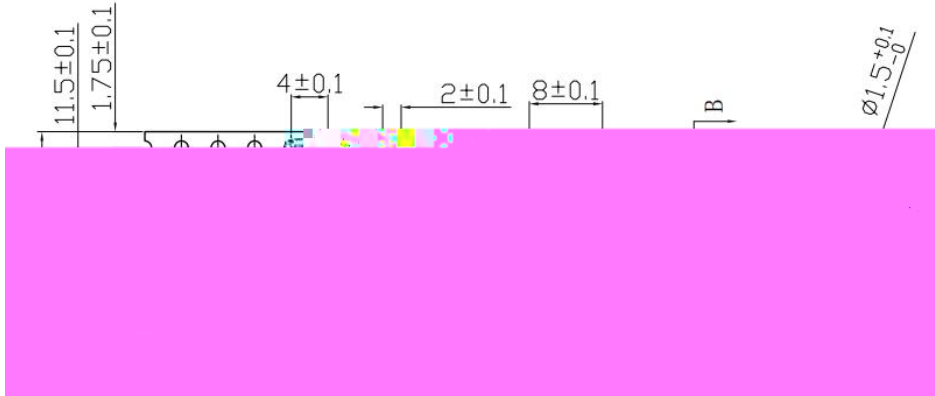

Item	Data	Remark
Cover tape adhesion	10 ~ 100g	Carrier tape and cover tape open angle 165 ~ 180° F=300±5mm/minute

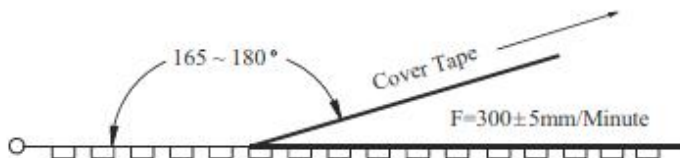

/ . .			

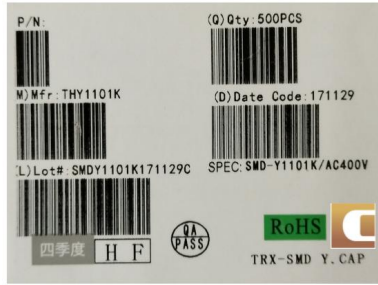
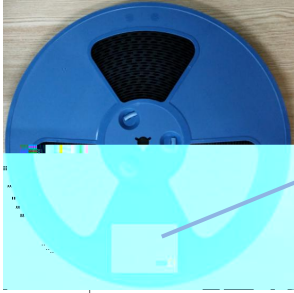

	/
	#

.0 /

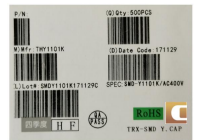
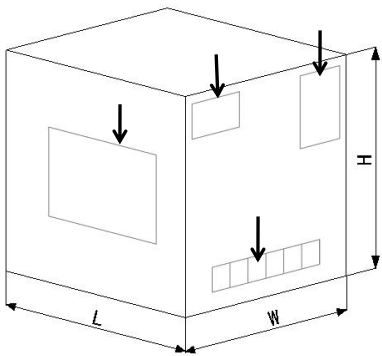

()			
		0	0.



0 /



00* 00* 0 (/ /)



00* 00* 00 (/ /)

&

0

&

-

0

/

/ . .			

()



	/ . .			

..

-

.

..

..

.....

.

.

..

..

,

*kkkk

	/ . .			

()

,

.

.

.

,

.



特锐祥

专注电容器 11 年

/ . .

0 - 00
0 - 00

/ . - (0 - -)

/ - 00 (0 -)

/ . - 00 (-)

() -

()

/ - ()

/ - ()

/ - 00

/ - 00

/ - 00

0 / / (.0)

00 / / ()

/ / 00 / 0/

/ / 0

0 / 00 ()

0

/ /

()