



_____ - 1 -()

一级代理商：

深圳市弗瑞鑫电子有限公司

地址：深圳市宝安区西乡大道302号金源商务大厦B座三楼

frxelec

- (1) (.50% 5 , 5)
- (2) - (5,000)
- (3) (.2. 2 , 2 , 100)
- (4) 000 / 2000
- (5)



- (. 323 44)
- (.4002 33)
- (. 0 00102 44)
- (. /043100)
- (. 0134201 0152)



- () ,
- ()



- (1) - 1 -()

- (2) 4- -

- (1)
- (2)
- (3)
- (4) ,
- (5)
- () , ,
- () - ,

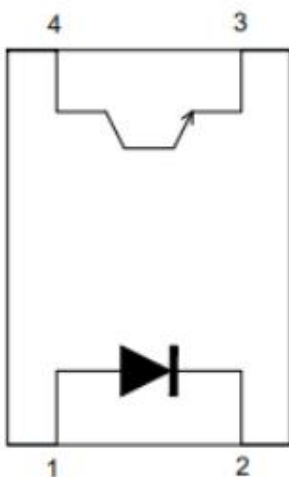

pin No. and Internal connection diagram

- 1 Anode
- 2 Cathode
- 3 Emitter
- 4 Collector



”



			---	1.2	1.4		20
			---	---	5		5
			---	10	200		0, 1
			---	---	100		20 0
			0	---	---		0.1 0
				---	---		0.1 0
	*1		50	---	00	%	5 5
			2.5	---	30		5 5
		()	---	0.1	0.2		20 1
			5 10 ¹⁰	1 10 ¹²	---		500 40 0% . .
			---	0.4	1.0		0, 1
	-		---	2 0	---		5 2 100 , -3
			---	2.	10		2 2 100
			---	4.5	10		
	-		---	.3	10		
	-		---	.1	10		

*1

/ 100% ,

3%.

	50	100	5 , 5 , 25	%
	0	1 0		
	130	2 0		
	200	400		
	300	00		

5	4	20	0.1 , 5 , 25	%
5	.5	34		
5	10	52		
5	15			
	24	2	0.5 , 5 , 25	
	40	120		
	0	140		
	0	2 0		
	40	105	1 , 5 , 25	
	5	1 0		
	100	2 0		
	150	3 0		



„

- 1 -()

(,)
(, , , , , 5, 5, 5...)

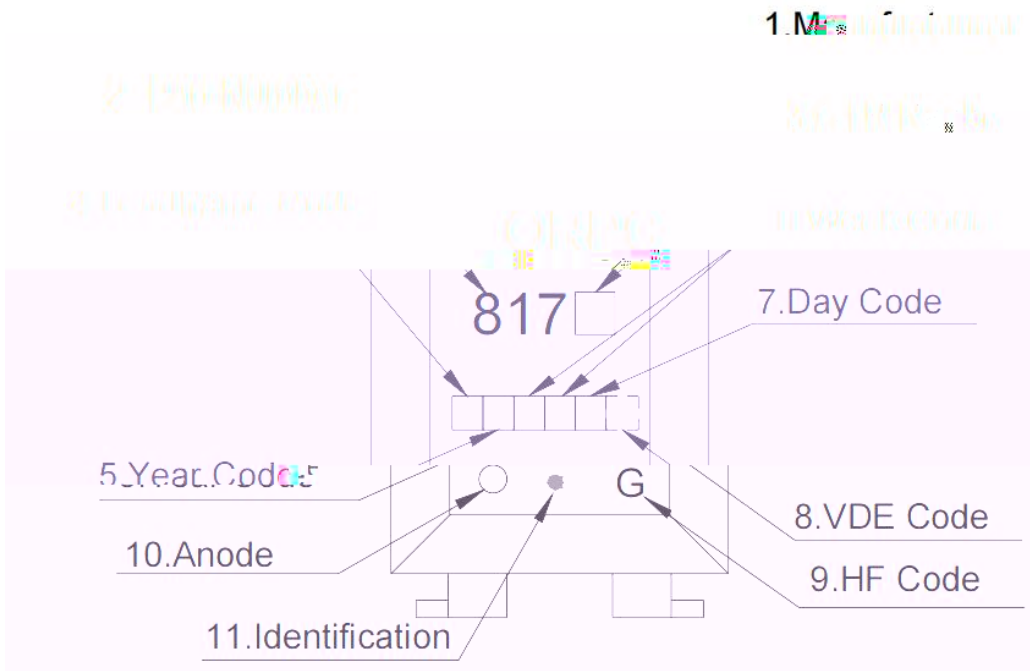

- (1) .
- (2) 1 .
- (3) . (, , ,)
- ()
- (4) .
- (5) .
- (6) .
- (7) .
- (8) . ()
- (9) . ()
- (10) .
- (11) .

* .

:)

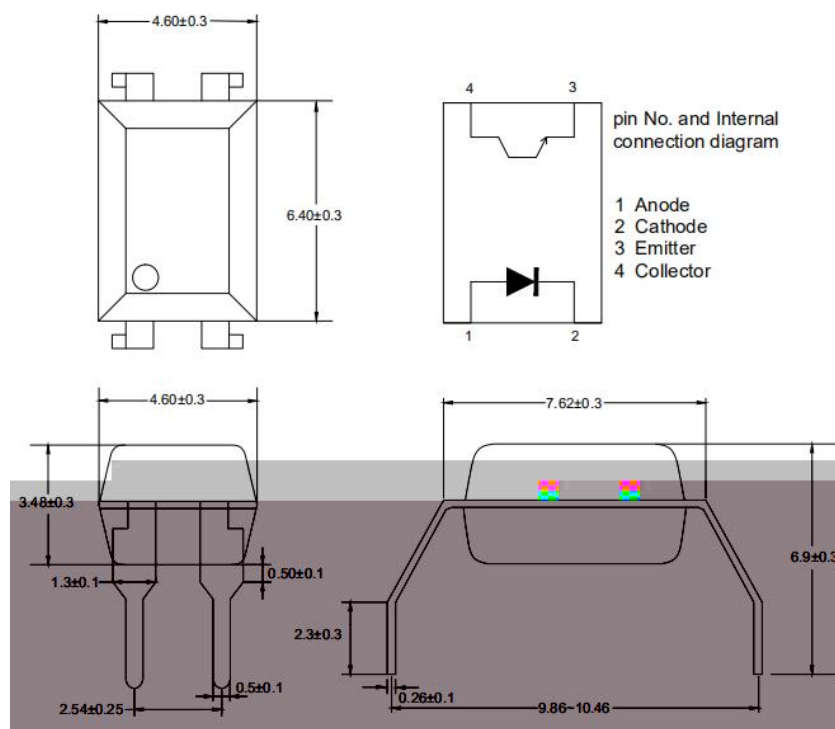
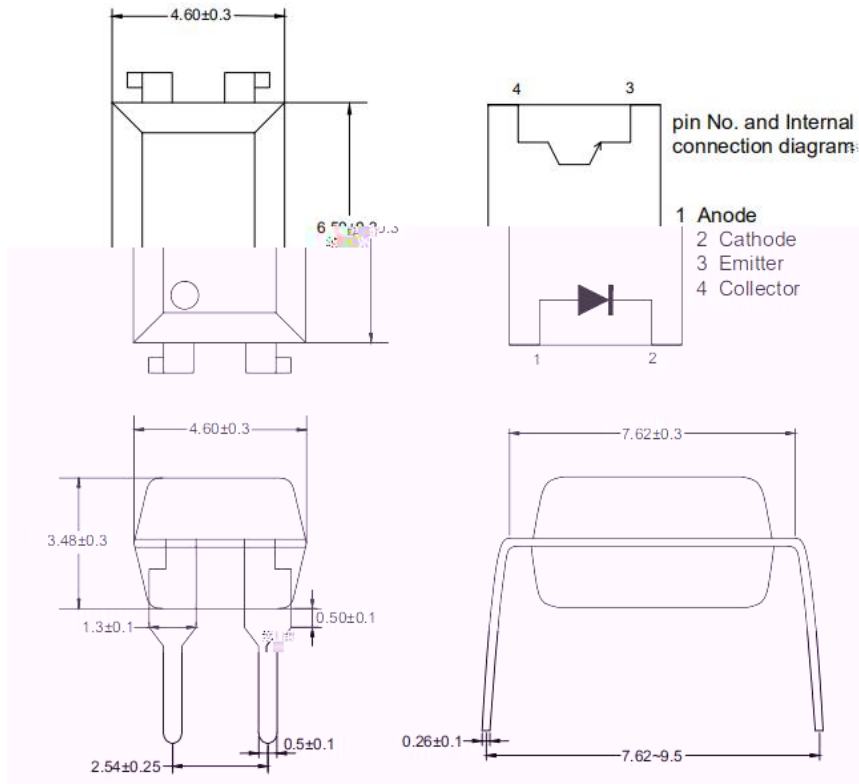



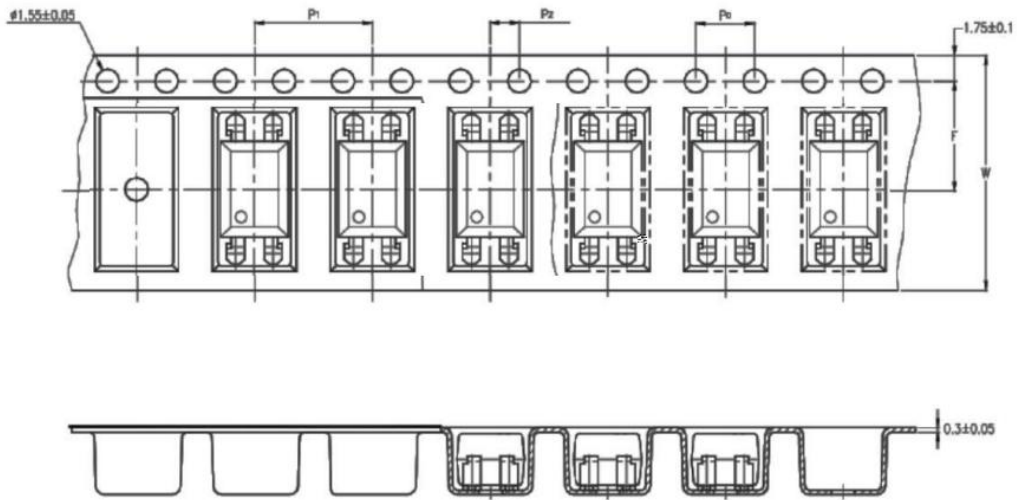

		1 0.3 (. 3)
	0	4 0.1 (.15)
		.5 0.1 (.2 5)
	2	2 0.1 (.00)
	1	0.1 (.4 2)

	/ 1
()	2000

:)

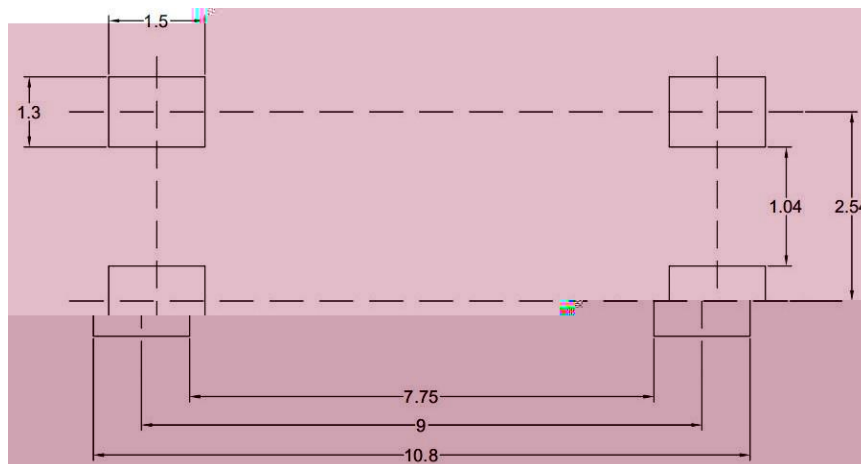



1	耐焊接热	22	20±5℃	10 /3 次	锡炉	JESD22-A106
2	高温存储	77	125℃	1	高温烤箱 测试仪	JESD22-A103
				500		
				1000		
3	低温存储	77	-55℃	1	低温箱 测试仪	JESD22-A119
				500		
				1000		
4	温度循环	77	125℃ 15 ∫ 5 -55℃ 15	300	冷热冲击机	JESD22-A104
5	温度冲击	77	100℃ 5 ∫ 15 -40℃ 5	300	冷热冲击机	JESD22-A106
6	高温操作	77	110° 10 5	1	高温烤箱 测试仪、老 化电路板	JESD22-A108
				500		
				1000		
7	人体模式	22	≥ 1	1次	ESD静电测 试仪	JESD22-A114
8	可焊性	22	245±5℃	5 /1次	锡炉	JESD22-B102
9	高温反向偏压	77	@125℃ 0	1	高温烤箱 , 测试仪	JESD22-A103
				500		
				1000		
10	3 温湿度反向偏 压, 寿命试验	77	3 5℃, 5% 0	1	恒温恒湿 机, 测试仪	JESD22-A101
				500		
				1000		
11	Autoclave 压力锅	77	121 ℃,100% ,2		压力锅	JESD22-A102

- ()	150
- ()	200
- () ()	0 30
- ()	21
- ()	0
	2 0
	20
-	3 /
-	3 /
	3

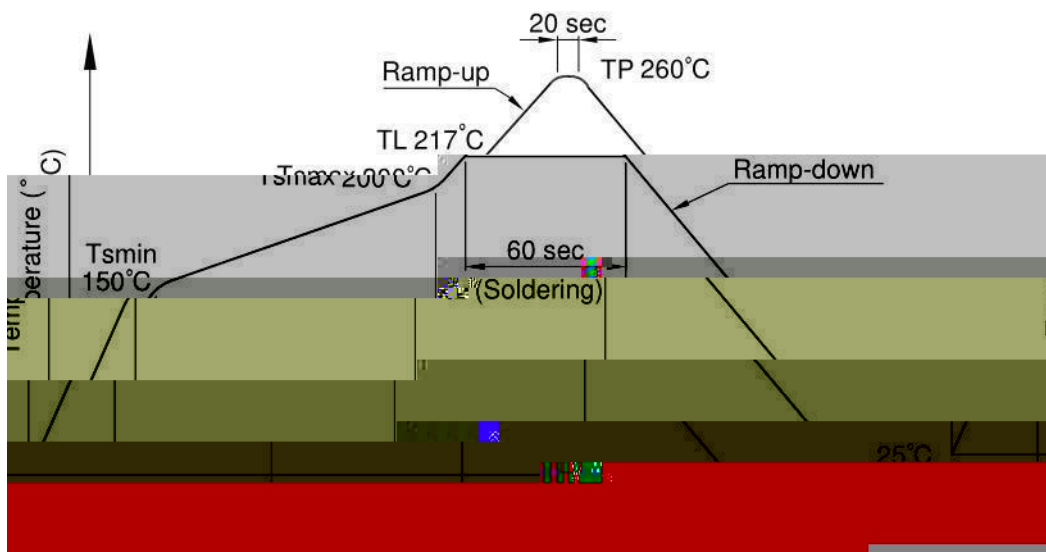



Fig.1 Forward current vs Ambient temperature

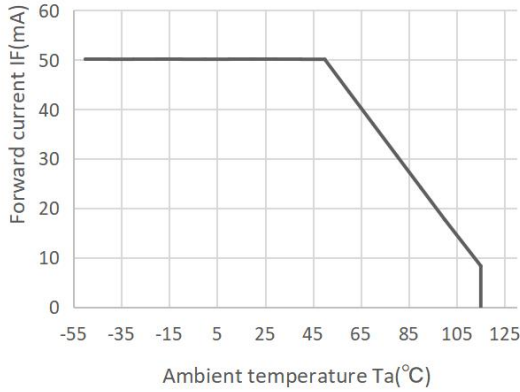

Fig.2 Collector Power Dissipation vs. Ambient temperature

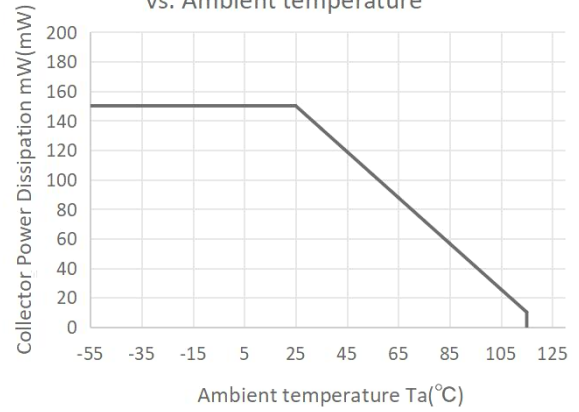

Fig.3 Collector-emitter Saturation Voltage vs. Forward Current

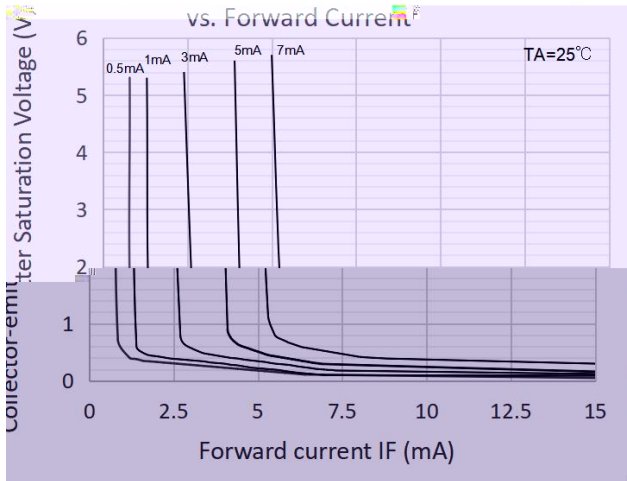

Fig.4 Forward Current vs. Forward Voltage

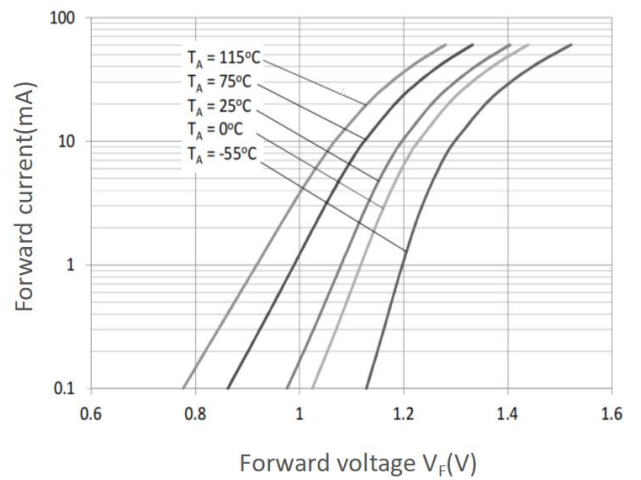

Fig.5 Forward Current vs. Current Transfer Ratio

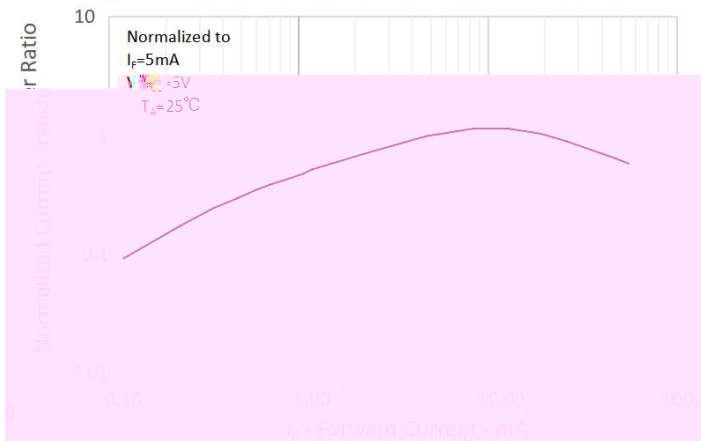

Fig.6 Collector Current vs. Collector-emitter Voltage

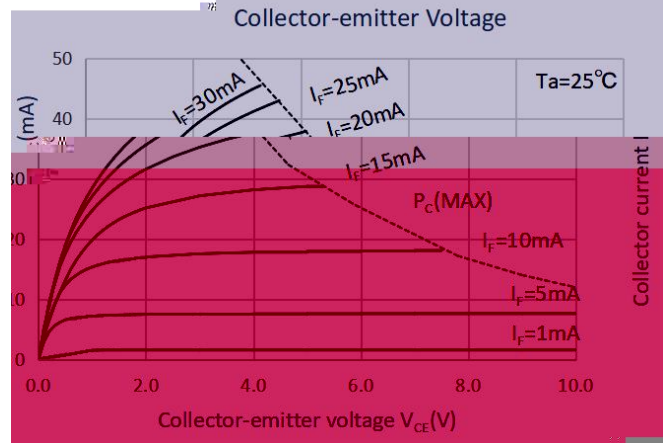

Fig.7 Relative Current Transfer Ratio vs. Ambient Temperature

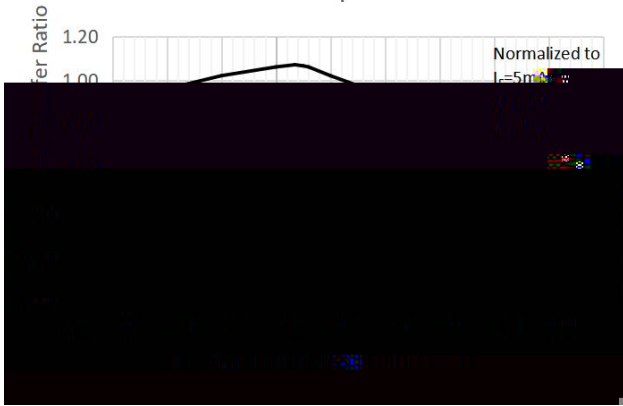

Fig.8 Collector-emitter Saturation Voltage vs. Ambient Temperature

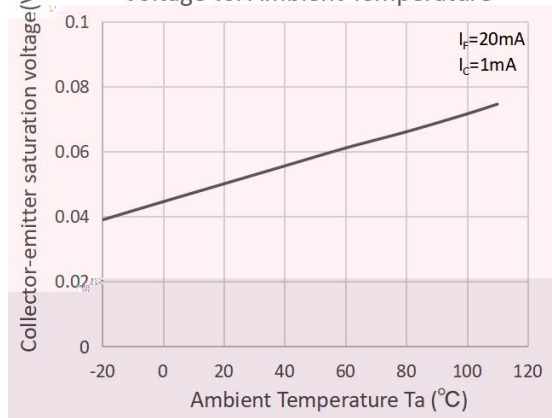

Fig.9 Collector Dark Current vs. Ambient Temperature

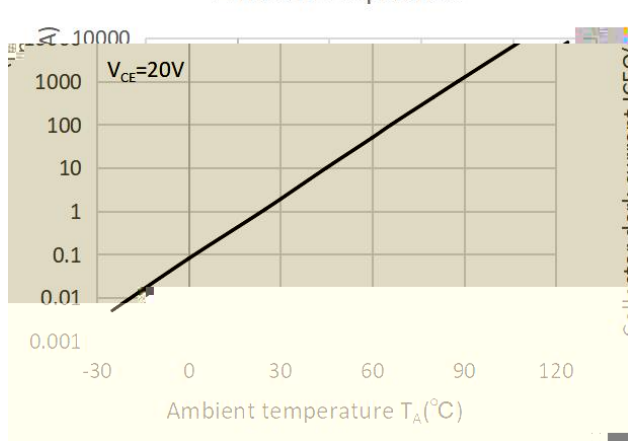

Fig.10 Response Time vs. Load Resistance

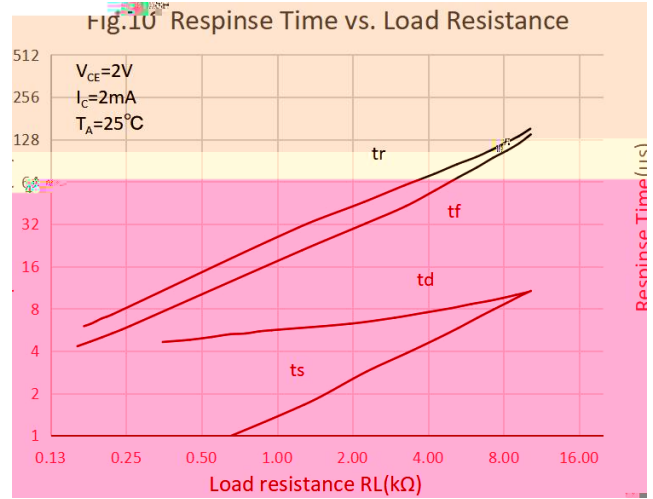
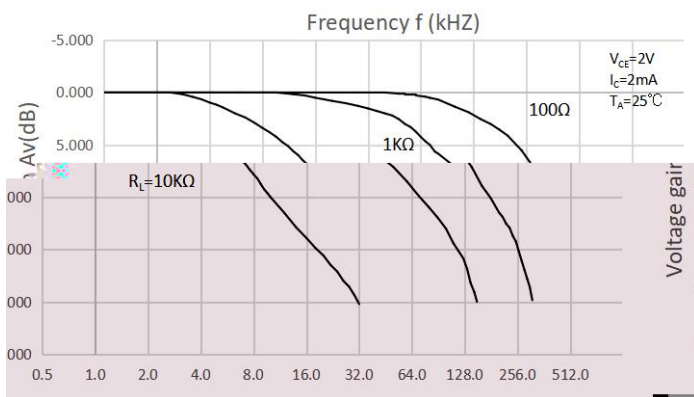
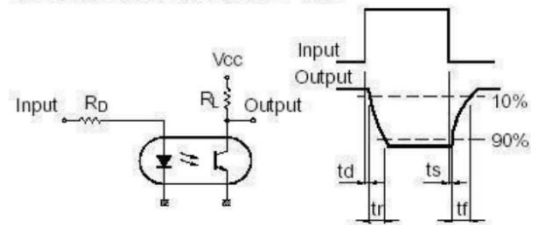

Fig.11 Frequency Response



Test Circuit for Response Time



Test Circuit for Frequency Response

