

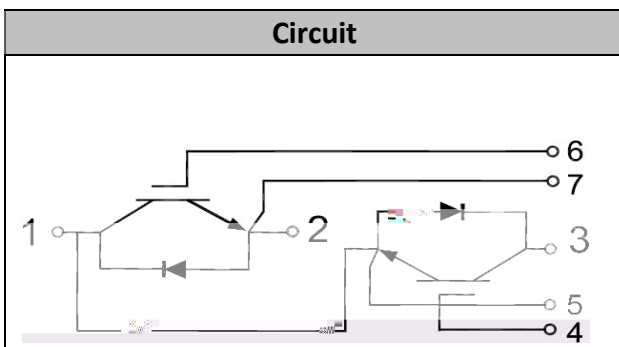

-, , R
1, =

- Dēdbam aj ea
- Ckh ē a a
- QLO Qj ē a l e l a Lk a O l l l a
- A l a e a h ē c i d ē a



- Dēd l a a E P ē JLP a d j k l k c
- Hk e d ē c k a
- Dēd d k e e l e - ,
- E h ē c h b k b a k a j ē l h a h B S
- Hk ē j a
- l ē i f j ē j a i l a a -1, °C

k l a k) A i e a R k h c a	R_{AO}	$R_{CA9}, R(E 9-i) = (P_f) 9.1^\circ C$	-, , R	R
k j ē k k l a k a j	E	$P 94, ^\circ C$	1, =	=
N a l a e e a L a g k l a k a j	E_{NI}	l 9-i	-, , =	=
C a) A i e a R k h c a	R_{CAO}	$P_f) 9.1^\circ C$	$\pm . ,$	R
P k h L k a e ē ē j	L_k	$P 9.1^\circ C$ $P_{fi} 9-1, ^\circ C$	0, ,	S

C a)ai ea Pd a dkh Rkh ca	R _{CA d}	R _{CA9} R _{Ai} E 9. 0i = (P f9. 1°C	1,	14	21	R
kth k)Ai ea)ktb aj	E _{AO}	R _{A9} -., , R(R _{CA9} , R(P f9. 1°C			- ,	i =
kth k)Ai ea O e j Rkh ca	R _A	E91, = (R _{CA9} -1R(P f9. 1°C		/ -		R
		E91, = (R _{CA9} -1R(P f9. 1°C		/ 4		
Ej l e j a	e	R _{A9} . 1R(R _{CA9} , R(0 /		jB
Na a aP j ba l e j a	a	b9-l D (P f9. 1°C		, . 2		jB
C a)Ai ea la g ca aj	E _{AO}	R _{A9} , R(R _{CA9} . , R(P f9. 1°C			0, ,	j=
P j)kj ah Pe a	j			//		j
NeaPe a		E 91, =		0/		j
P j)ktb ah Pe a	ktb	R _{A9} 2, , R R _{CA9} -1R		-4-		j
B hPe a		N _{CKJ} 9 -,		2,		j
Ajac e e e j e c P j)kj Pe a	A _{kj}	N _{CKBB} 91 - P f9. 1°C		/ ,		i F
Ajac e e e j e c P j)ktbPe a	A _{ktb}			- . /		i F
P j)kj ah Pe a	kj			/ 4		j
NeaPe a		E 91, =		03		j
P j)ktb ah Pe a	ktb	R _{A9} 2, , R R _{CA9} -1R		.. ,		j
B hPe a		N _{CKJ} 9 -,		21		j
Ajac e e e j e c P j)kj Pe a	A _{kj}	N _{CKBB} 91 - P f9-. 1°C		1 21		i F
Ajac e e e j e c P j)ktbPe a	A _{ktb}			- 4		i F
O	E	P _i -, (R _{CA9} -1R(P f9-. 1°C(R _{A9} 2, , R(R _{AI} -., , R		0, ,		=

Nal a eea La g Na a a Rkh ca	R _{NNI}	P _i 9. 1°C	-.,,	R
kj ě k Bk aj	Ⓔ		1,	=
Nal a eea La g Bk aj	Ⓔ _{NI}	i9-i	-,,	=

Bk Rkh ca	R _B	Ⓔ91, = (P _i 9. 1°C Ⓔ91, = (P _i 9. 1°C	. -, . 0,		R
Na k a a d ca	M	Ⓔ 91, =	. 10		
La g Na a a Na k a aj	E	R _N 92, , R) Ⓔ 91, =	/		=
Na a a Na k a Aja c	A	P _i 9. 1°C	, 3.		i F
Na k a a d ca	M	Ⓔ 91, =	0 2		
La g Na a a Na k a aj	E	R _N 92, , R) Ⓔ 91, =	04		=
Na a a Na k a Aja c	A	P _i 9-. 1°C	- 1-		i F

Ekh & j kh ca	R _{ekh}	9-i & (01, D	.1,,				R
I é i F j & j Pai la a	P _{fi}					-1,	°C
Kla & c F j & j Pai la a	P _{fkl})0,			-1	°C
Ok ca Pai la a	P _c)0,			-1	°C
Pda i hNa e j a F j & j)k a	N _{oF}	la & P					GS
		la & a					
Pda i hNa e j a a)k O& g	N _o	kj eaca a ll&				,,1	GS
I k & a k a Fk ma	I	Na ki i aj a l 1	.1			1,	J i
I k & a)k O& g Fk ma	I	Na ki i aj a l 2	/,			1,	J i
S a& d kbl k &	C					-1,	c



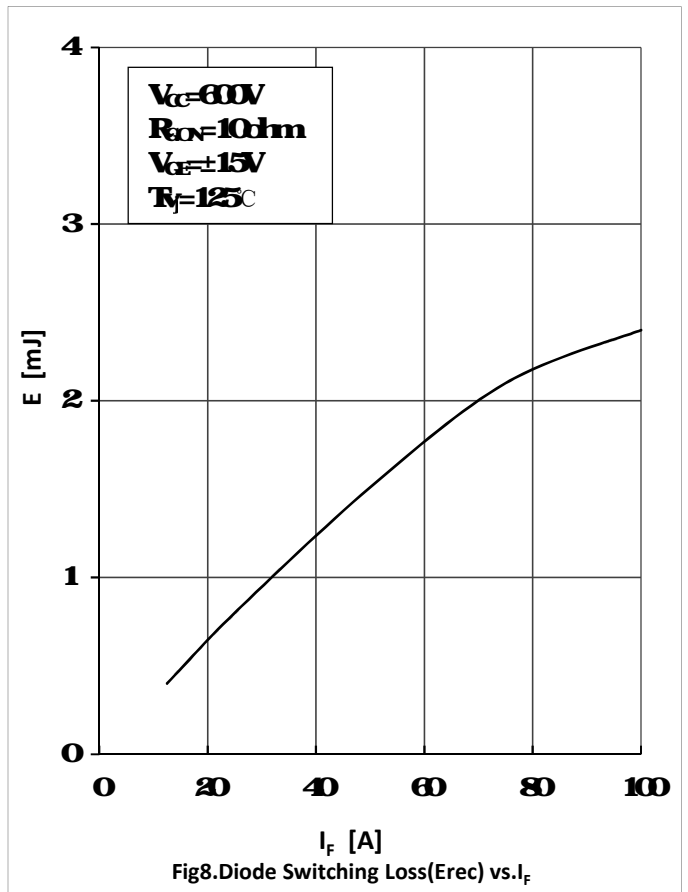
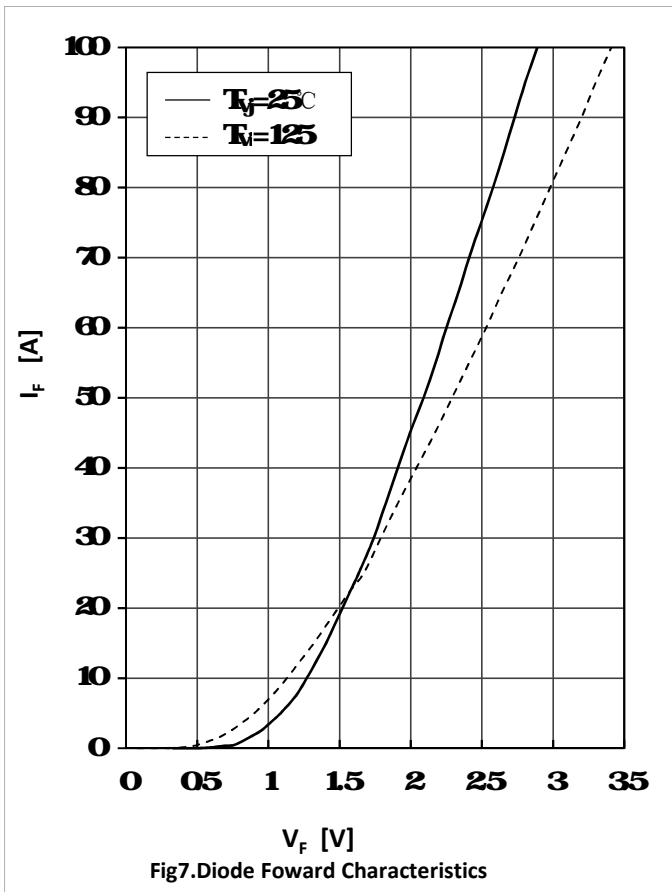
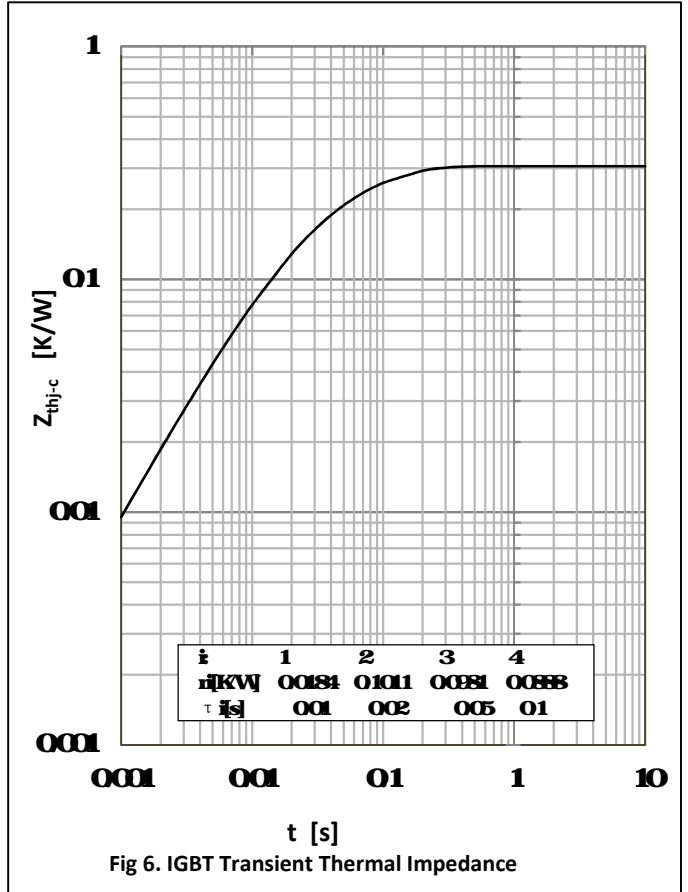
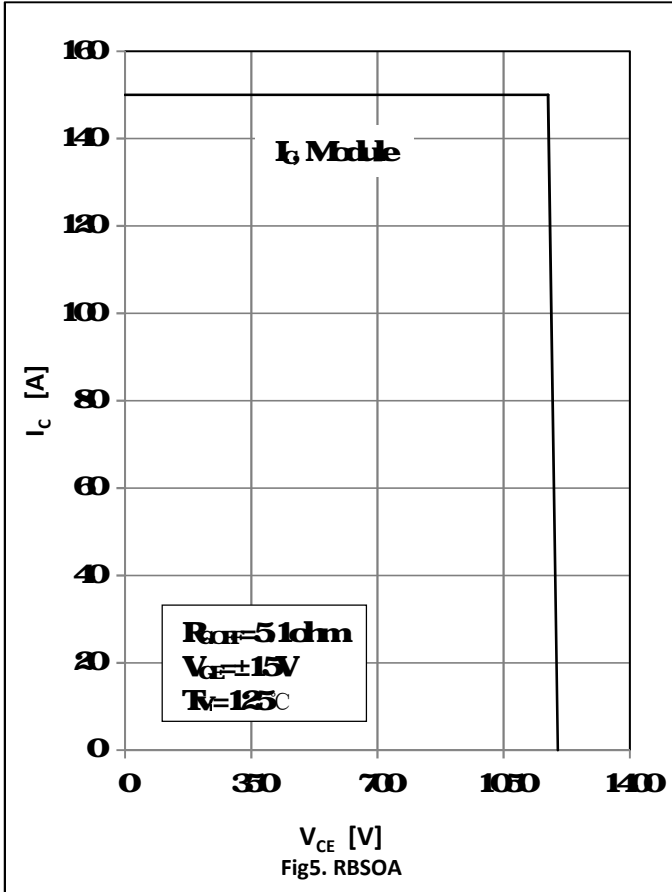

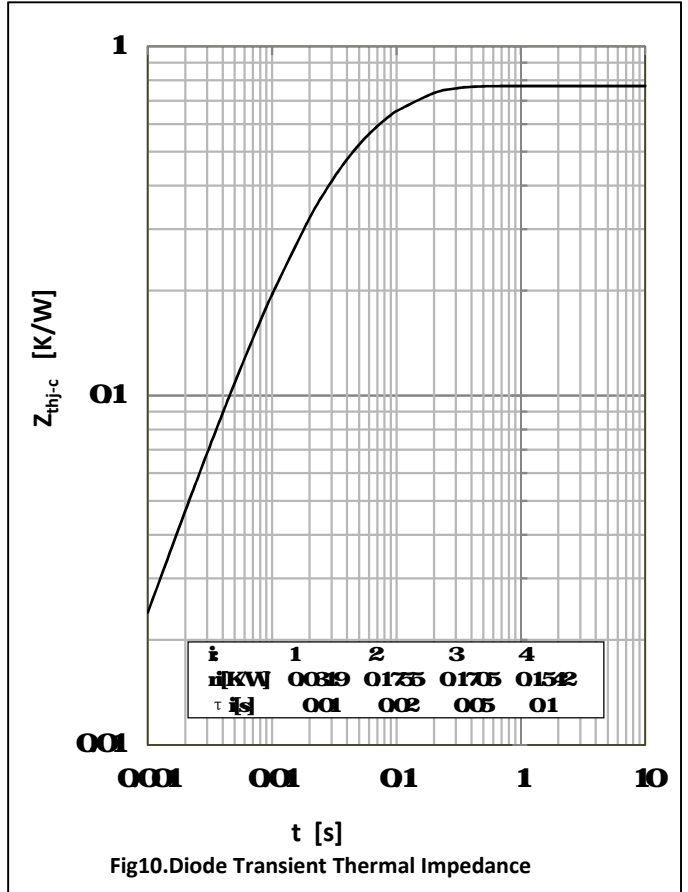
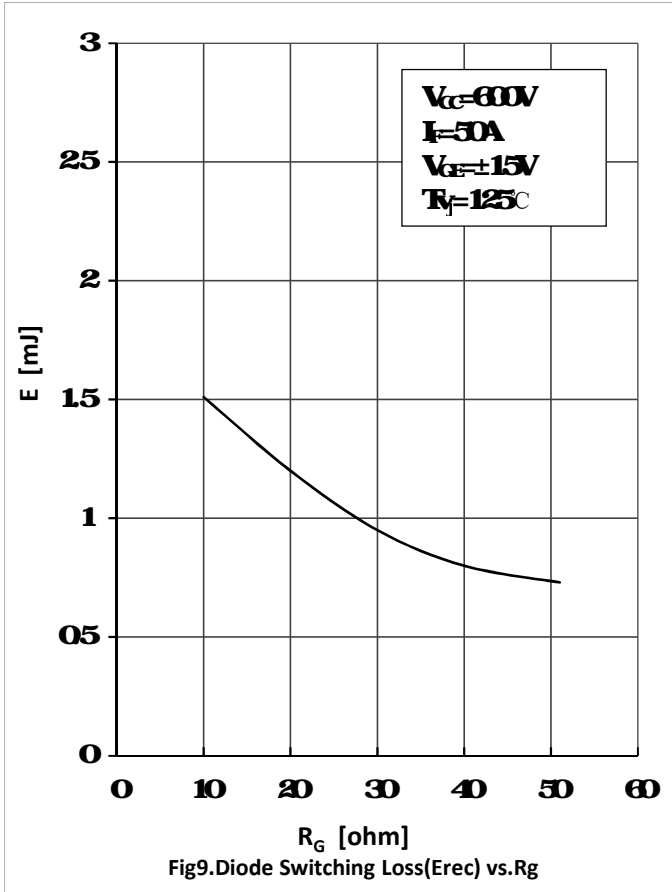



o